

# CATALOG 2021

## PRODUCTS AND SOLUTIONS

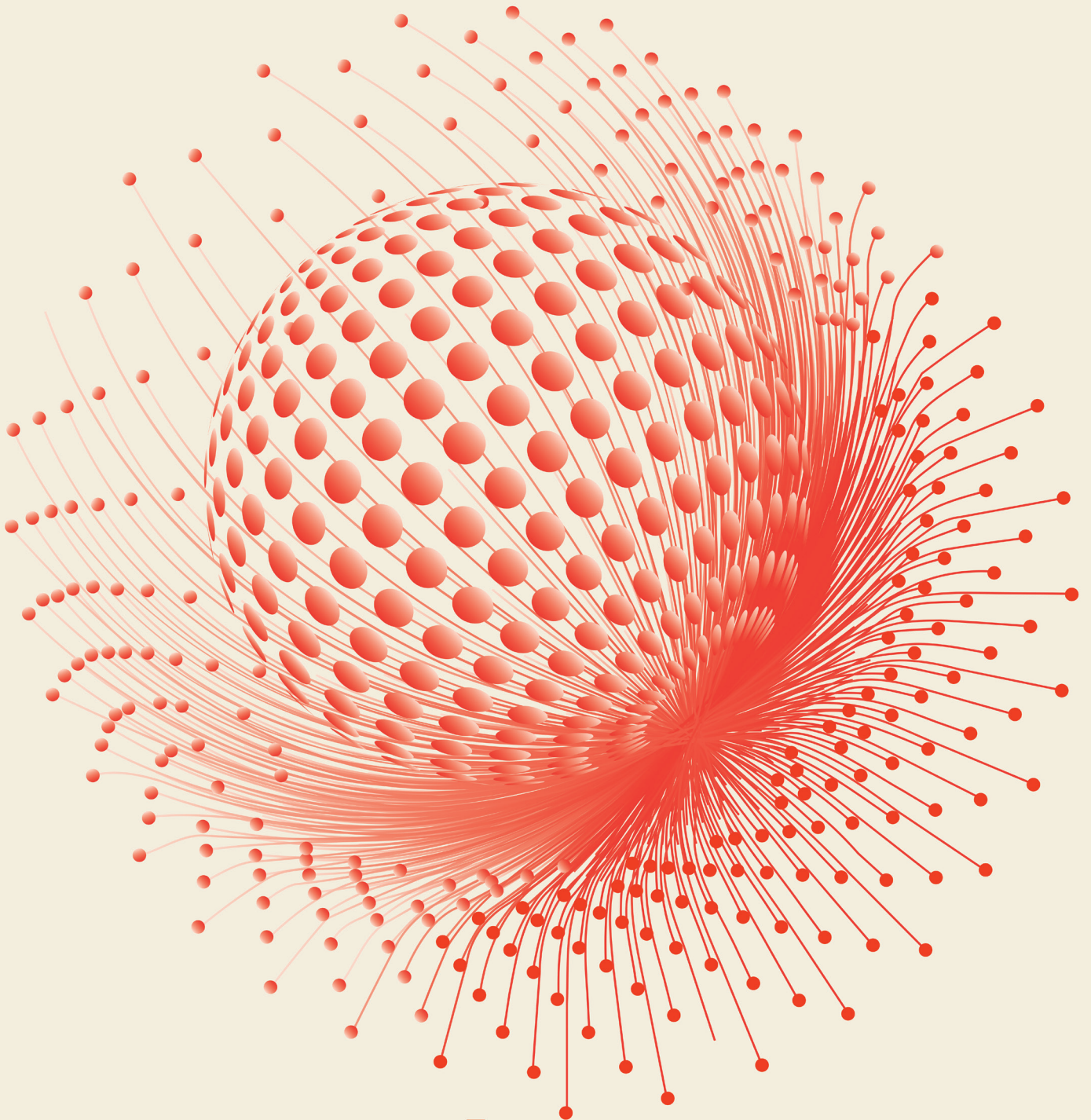





# About Raisecom

Raisecom is a global leading vendor providing comprehensive access solutions and network devices. With headquarters in Beijing (China) and listed on Shanghai Stock Exchange (SHA:603803), Raisecom has consistently strong growth with partners and customers over 80 countries worldwide.

We have two Research and Development centers located in Beijing and Xi'an, as well as two manufacturing sites in Beijing and Shenzhen. Internationally, there are several branches and representative offices, and Raisecom Inc. located in Texas, USA. We also have specialized teams to tailor solutions for various networks like access, optical network, cloud service, IoT network together with vertical market segments.

Raisecom is ISO9001:2015 certified for RnD, manufacturing, technical support and marketing and our products are compliant with CE, RoHS, IEEE, IEC, CSA standards and regulations.



RAISECOM



# Solutions



Service Providers/MSO .....	04
Mobile .....	11
Broadband Access .....	15
Mission Critical Networks .....	19
Enterprise and Government .....	23

01

**Carrier Ethernet**

Intelligent Ethernet Demarcation Device ..... 29

Intelligent 10G Ethernet Demarcation Device ..... 30

02

**IP MPLS**

IP-MPLS Pre-Aggregation and PE Device ..... 31

MPLS Pre-Aggregation Pizza-Box ..... 32

03

**Optical Transport Network**

Multi-Service OTN Platform ..... 33

Compact Multi-Service OTN Platform ..... 34

Standalone Multi-Service OTN Platform ..... 36

OTN 100G/200G Standalone Device ..... 37

WDM Semi-Passive Device ..... 37

**xPON**

xPON OLT ..... 38

Medium xPON OLT ..... 39

Standalone EPON OLT ..... 40

Outdoor GPON OLT ..... 41

GPON SFU ONT ..... 41

GPON HGU ONT ..... 42

SOHO/Enterprise Gateway ..... 42

GPON Stick ONT ..... 45

Standalone CATV EDFA ..... 45

Splitter ..... 45

04

**Smart Home Routers**

Residential Routers ..... 46

G.hn Routers ..... 47

05

**WLAN**

AC Device ..... 48

Intelligent and high performance standalone AC ..... 50

Comprehensive gateway integrated AC ..... 52

Wireless APs ..... 54

06

**Industrial Switch**

L2 DIN-Rail Manageable Industrial Switch ..... 56

L2/L3 19" Rack-mounted Manageable Industrial Switch ..... 58

3G/4G Router ..... 59

IoT Gateway ..... 59

07

08

**Small Cell**

Micro/Pico/Femto Cell Device ..... 61

09

**Multi-Service Access Platform**

Multi-Service Chassis ..... 62

Dual-Core Architecture PTN Aggregation platform ..... 63

Compact PTN Aggregation Platform ..... 64

10

**Network Management System**

Topology Management ..... 67

Inventory Management ..... 67

Configuration Management ..... 67

Fault Management ..... 68

Customer Management ..... 68

Performance Management ..... 68

Security Management ..... 69

Web Management ..... 69

Zero Touch Provisioning ..... 69

SLA Portal ..... 70

**PRODUCT**



## Service Providers/MSO

Raisecom telecommunications solutions present a comprehensive range of access solutions and technologies, targeting telecom service providers, large enterprises, financial institutions, government, educational organizations, health centers, and other public establishments, where mission-critical tasks as well as conventional data communication are delivered and processed quickly.

Raisecom solutions deliver services with assured bandwidth, guaranteed data security, minimized network outages, and with the ability to deliver end-to-end Carrier-grade services with a reliable and predefined SLA. Since our solutions enable highly resilient services with L2/L3 demarcation in a versatile access infrastructure with access data rate ranges from 2Mbps to 100Gbps, they meet requests for every segment in the market.

Telecom operators offer a variety of services, while attempting to maximize their infrastructure. As a partner, Raisecom provides the most flexible combinations of product solutions which bring advanced networking technologies, end-to-end management, and easy-to-maintain and easy-to-use solutions together.



## IP/MPLS Access and Pre-Aggregation Solution

- Support abundant MPLS services(VPWS/VPLS/L3VPN)
- End-to-End MPLS service reduces the OPEX by simplifying the network routing and provisioning process
- Multi-level MPLS service (Ethernet + Static MPLS + IP/MPLS) makes network more flexible
- LSP/PW protection by 1:1 hot-standby or FRR enhances the network reliability
- MAC-Learning-Disable and L2CP offer transparent forwarding for service traffics and L2 protocol packets
- Y.1731 for L2VPN and TWAMP for L3 VPN performance monitoring assure the service-level-agreement
- Zero-touch-provisioning makes quick deployment

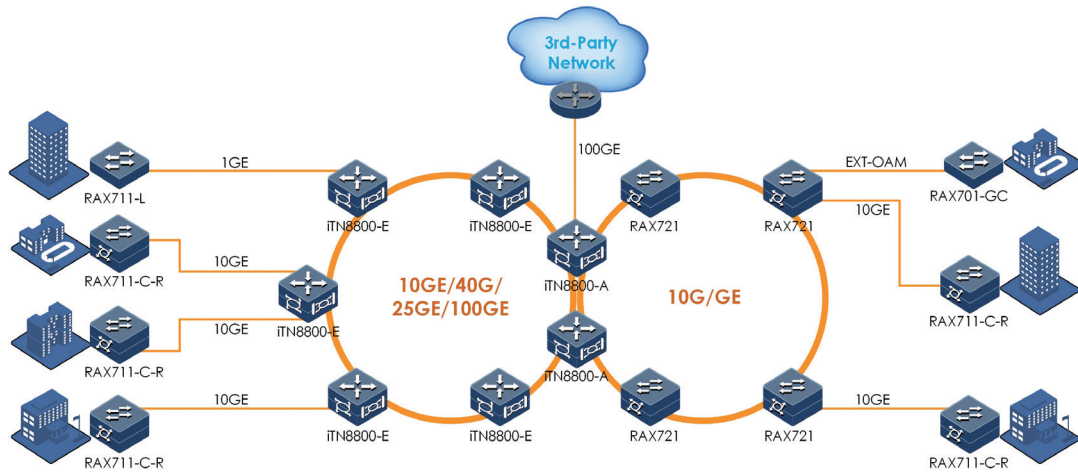

## 100G Point to Point DCI Solution

- Support 100G/200G CFP2 (Coherent, Grey LR4/ER4) on line port
- Maximum transmission distance for 40 x 100G: 16 x 22dB
- 100G/200G line port: GFEC, SD-FEC
- Flexible wavelength configuration
- Up to 40 x 100G/200G capacity
- Multi-service access in client side: Ethernet, OTN, SDH, FC
- Support encrypted transmission on the client side and line side
- Support G.HAO

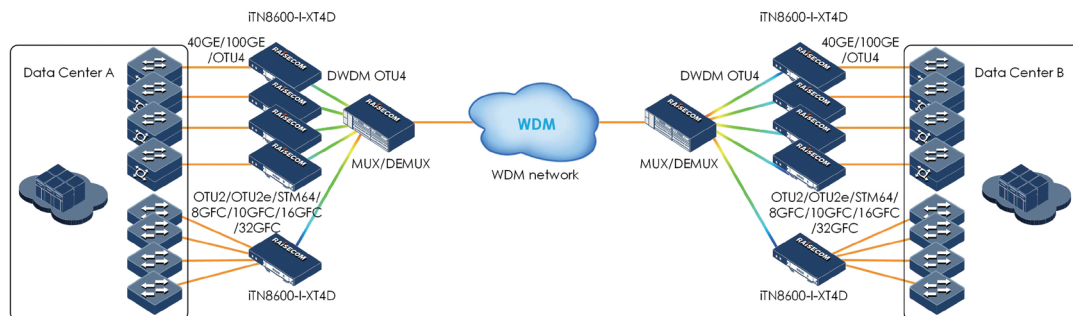

## High Performance EVC-based Business Services

- Support MEF CE2.0 based standard EVC services E-Line, E-Lan, E-Tree
- Intelligent EDD RAX711 series offer fast end-to-end services deployment by zero-touch-provisioning
- High capacity pre-aggregation devices RAX721/iTN8800-E offer reliable aggregation rings
- QoS by traffic-policing, queue shaping, queue scheduling assures the service quality
- Y.1564/RFC2544 service activation test from UNI to UNI
- SLA sessions by Y.1731 LM/DM or TWAMP offer visible performance monitoring result

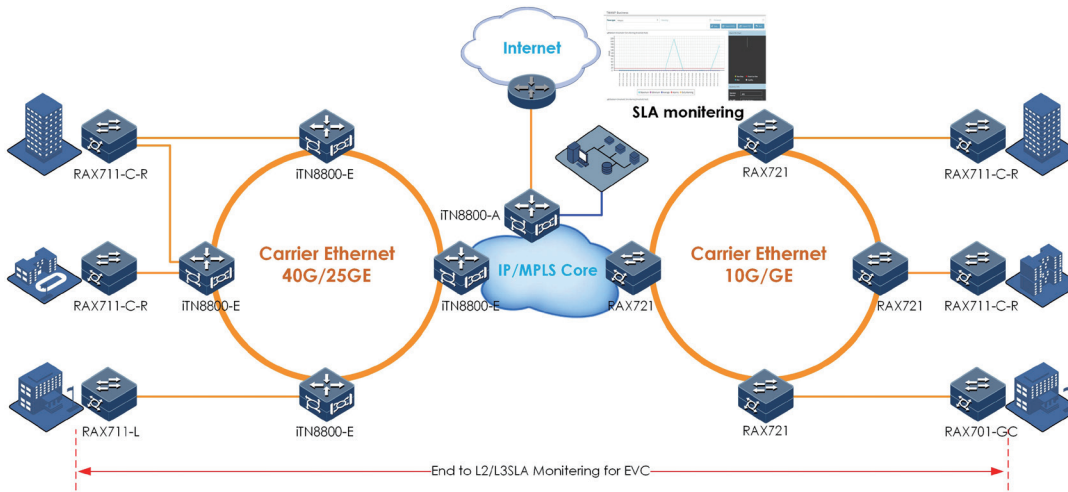

## High Performance OVC-based Wholesale Services

- Support MEF CE2.0 based standard OVC services E-Access
- Intelligent EDD RAX701/RAX711-L acts as UNI node, RAX711-C-R acts as ENNI node
- QoS by traffic-policing, queue shaping, queue scheduling assures the service quality
- Y.1564/RFC2544 service activation test from UNI to ENNI
- SLA sessions by Y.1731 LM/DM or TWAMP offer visible performance monitoring result

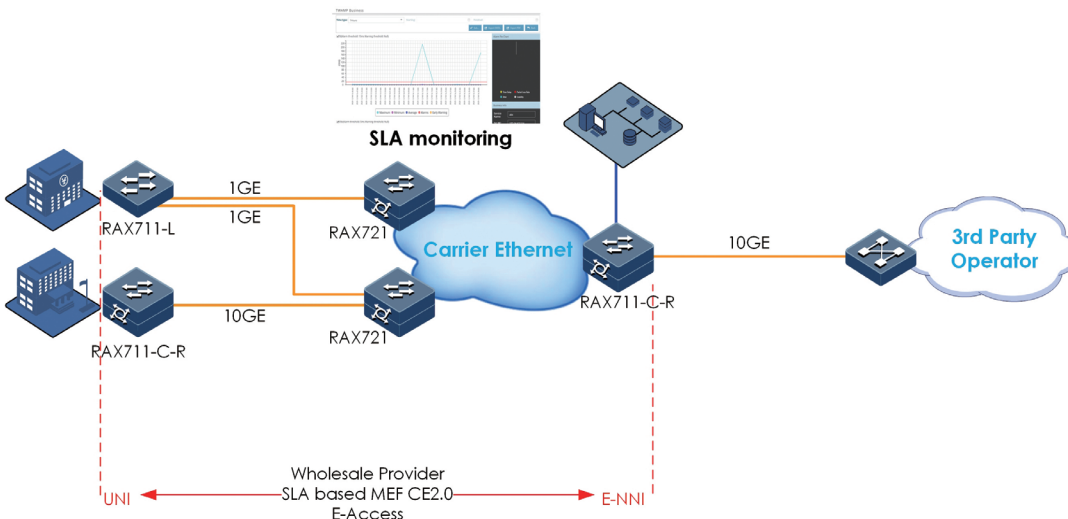

## TDM Extension over Packet Network

- Ensure service providers a smoothly infrastructure migration from TDM to packet-based
- Various legacy service access ability provides flexibility when facing different network terminals
- Pseudo-wire solutions ranges from CPEs to medium and large aggregators
- Packet-switched/TDM dual-platform design
- Flexibility of TDM emulated services:  $n \times 64k$  and E1
- Pseudo-wire services can be delivered over point to point and point to multi-point topologies
- SyncE and standard clock features guarantee high-quality synchronization of TDM services

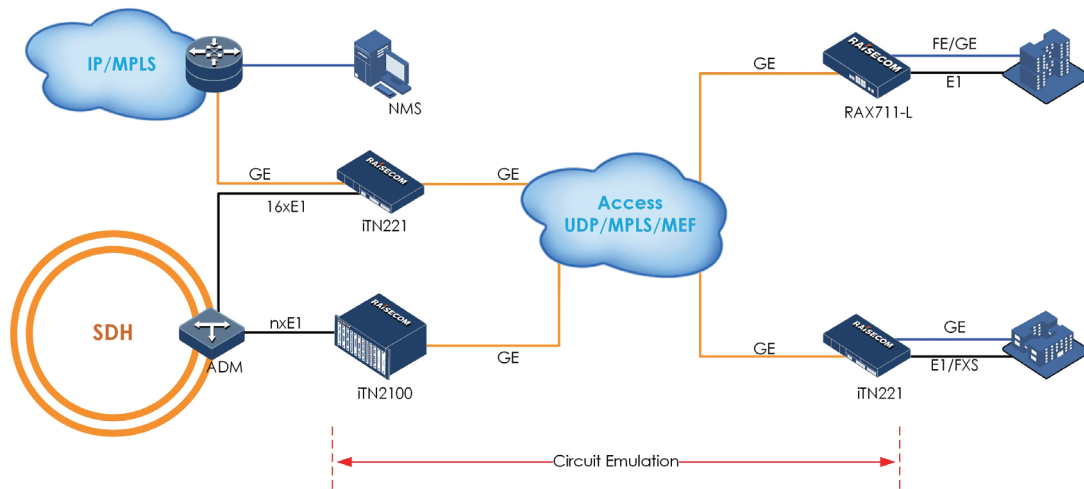

## Business Connectivity with 4G/5G Backup

- Extend customer range and increase customer base by using 4G/5G mobile network
- Industrial-grade design with both fiber and 4G/5G uplink ensuring reliable delivery of customer services
- Ordering options available to fit in sites with different access capacity
- Support multiple VRF for management traffic and service traffic separately

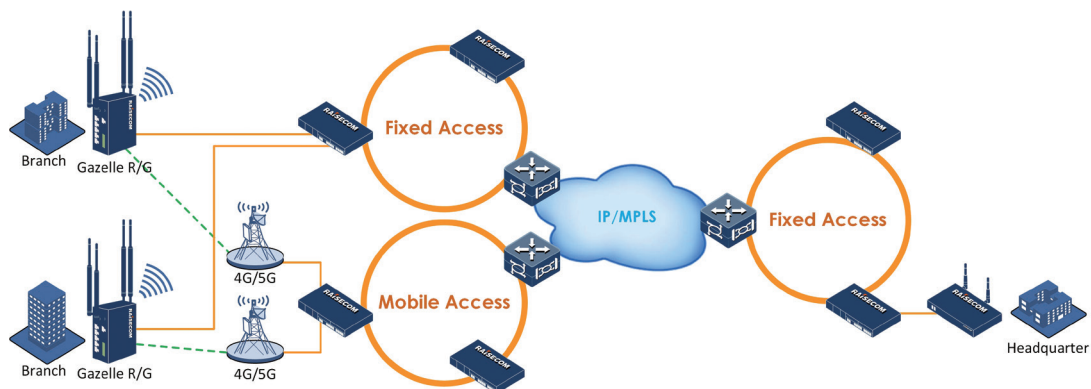

## Virtualized Application over Cloud

- Provide ONAP, ETSI born end-to-end service-driven abstract and flexible orchestration, based on Openstack architecture
- Portal/APP based multi-level self-service: such as carrier level, enterprise level and end-user self-service
- Minutes level service end-to-end provisioning and turn-up
- Convenient overlay VPNs to connect no matter what services subscriber needs: IP, MPLS, or Internet network service
- Highly flexible, on-demand elastic adjustment
- Highly stable, on-demand back-up
- Be compatible with the 3rd party VNFs capabilities
- Real future-proof CT and IT combined architecture, pay-as-you-grow, effectively reduce CAPEX and OPEX

### iDirect Connection service:

- Customer service connection to data center

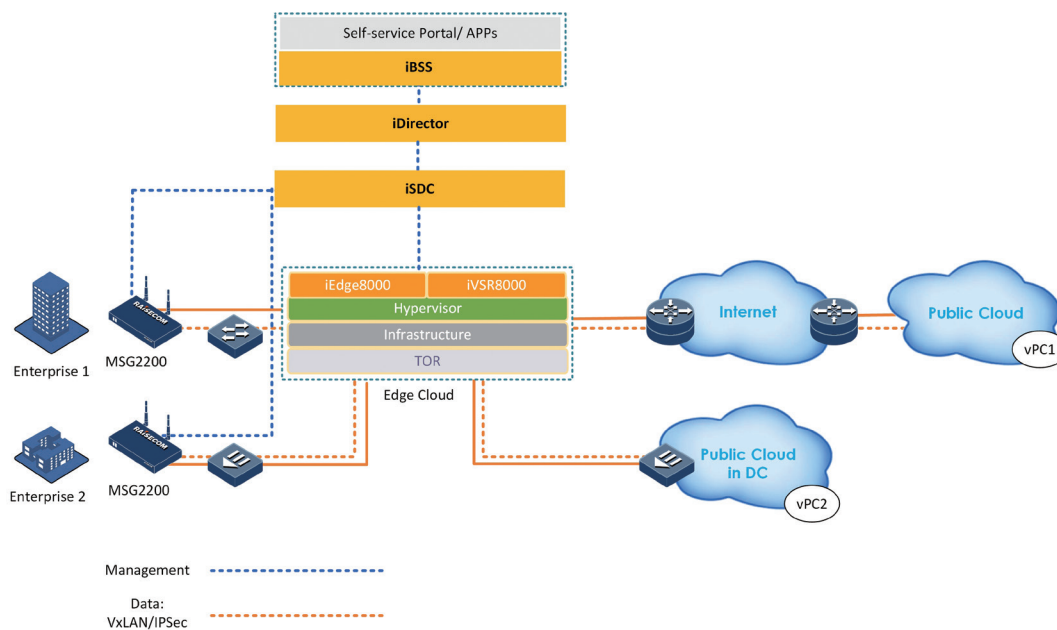

### Multi branches connection service:

- VPN interconnection between HQ and Branch

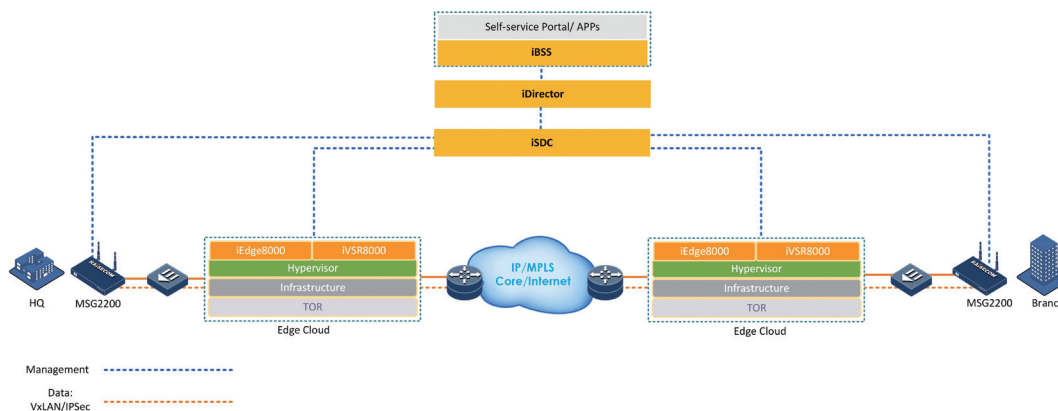



## Flexibly enhance enterprise IT infrastructure service:

- Eliminate the need to buy individual pieces of equipment for VPN, router, voice and other network functions, IT services can be downloaded as subscriber requires

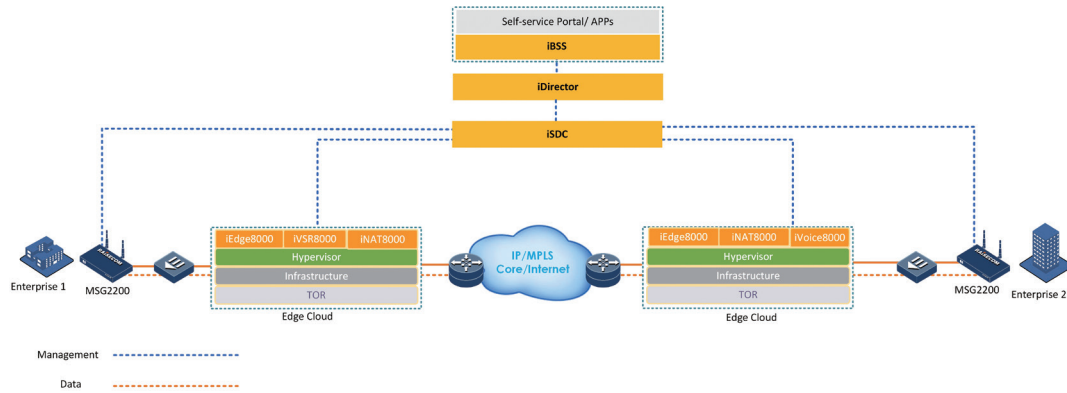

## Service access to cloud for acceleration:

- Easy connection adapter between CPE and acceleration network POP site

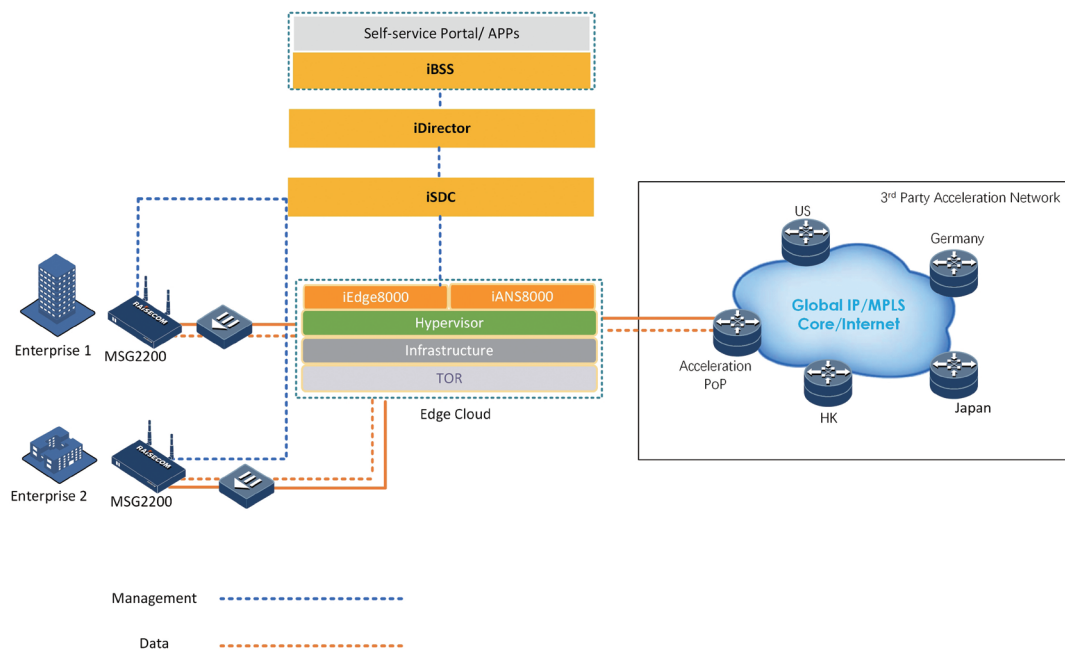

## Multi-Service Optical Transport Network Access Solution

- The iTN8600 series can be deployed as access and aggregation nodes
- The iTN8600 series can build a full service access platform in the metro area
- The iTN8600 series can provide many service types like 1GE/10GE, STM1/STM4/STM16, OTU1/OTU2, FC1/FC2/FC4/FC8/FC10, CPRI, OBSAI, etc.
- In leased line application, Raisecom has iTN8607 PIZZA Box series on remote site connected to iTN8600-A
- Support leased line, fixed line backhaul and wireless backhaul networks
- The solution can offer seamless connection with core and aggregation layers by PTN/OTN/SDH
- Manage, enable and deploy services automatically from the iTN8600 NMS

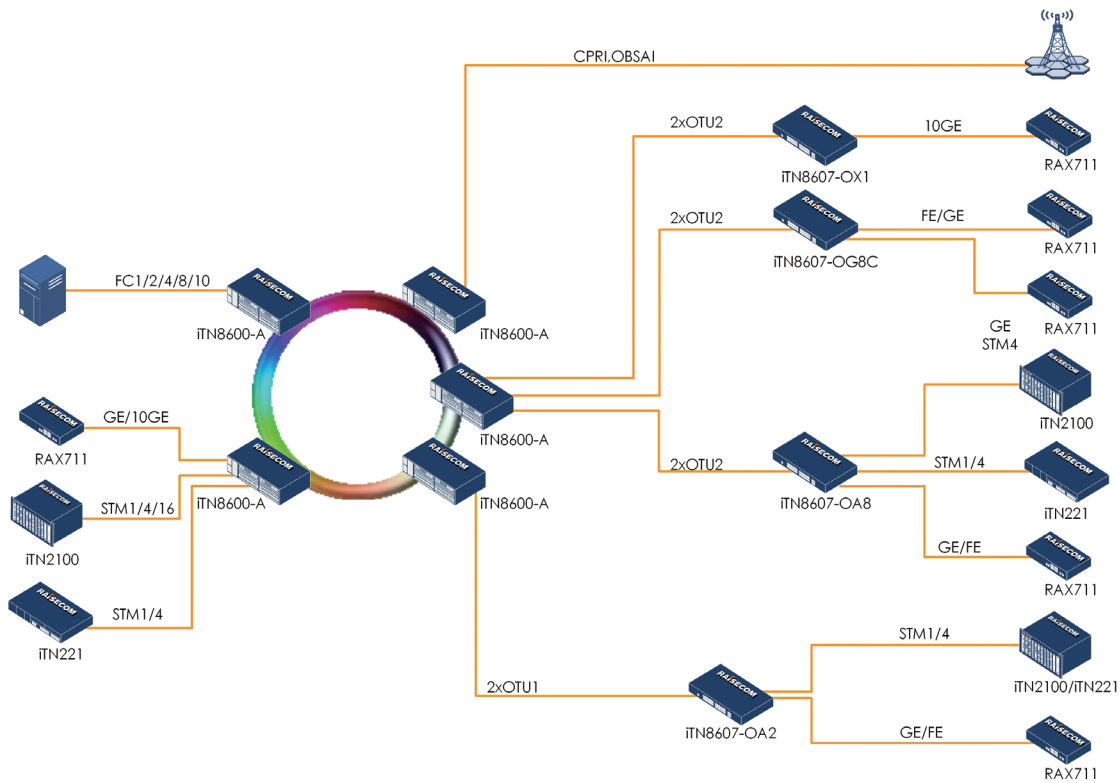

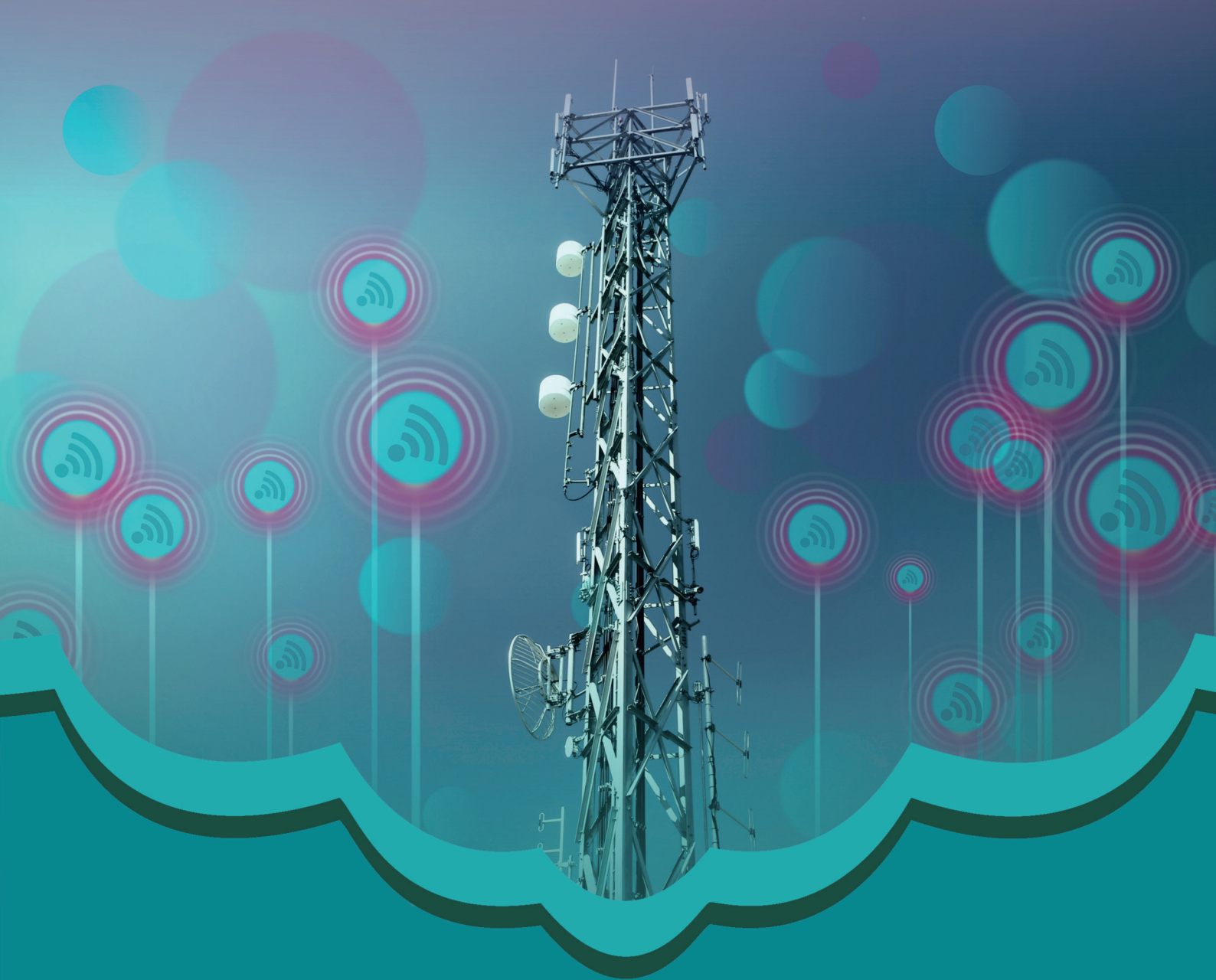

## Mobile

The constantly growing number of bandwidth-savvy smartphones and mobile devices drives mobile operators to improve their networks. This includes improved efficiency, increased bandwidth capacity and expanded coverage. The choice of mobile backhaul and fronthaul technologies is becoming a crucial factor for operators aiming to deliver guaranteed mobile services and remain profitable in an era of declining ARPU.

Raisecom mobile backhaul solutions support voice-sensitive and data-intensive traffic at affordable costs. They enable reliable and smooth migrations of multi-G (2G, 3G and 4G/LTE) mobile services over legacy, and packet-based or Metro Ethernet networks. These carefully engineered solutions include some of the following capabilities: auto-provisioning, bandwidth optimization and performance monitoring, which assist in reducing OPEX and increasing network availability. Raisecom's mobile backhauling solutions support various technologies like Carrier Ethernet and IP/MPLS, hence enabling network-wide packetization of operators transport networks.

Raisecom BBU fronthaul solution is used to deliver BBU functionality by Passive Optical Network, xWDM technology or OTN. It helps carriers to dramatically reduce cost and enlarge wireless coverage. The diversified solutions can meet different scenarios for different requirements.

## 5G Mobile Backhaul over MPLS

- High density interfaces for 5G service access
- Up to 100G aggregation ring offers ultra-high bandwidth, ultra-low latency, and ubiquitous connection
- 5G services can flexibly adopt either L3 to edge HoVPN or L2VPN access to L3VPN
- Comprehensive timing synchronization: SyncE, 1588v2 TC
- TWAMP based real time performance monitoring for L3 service

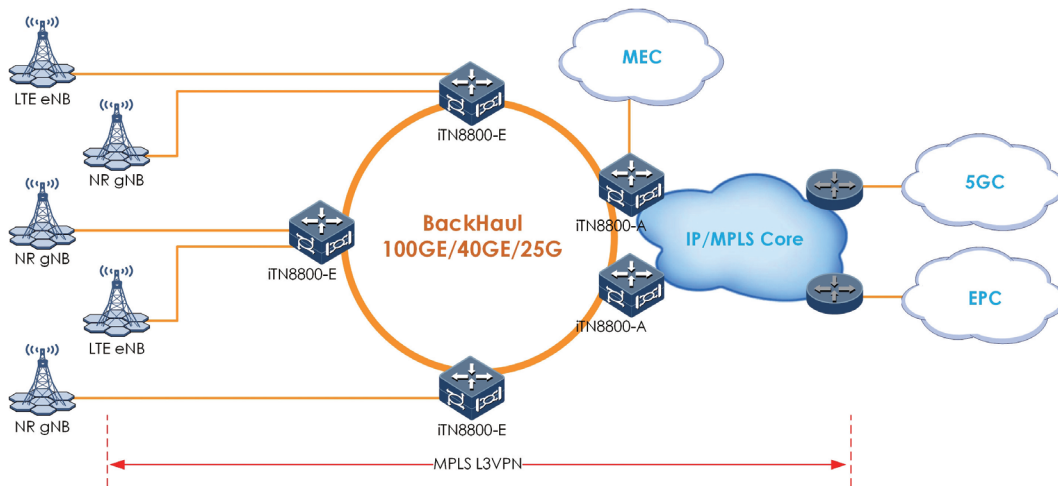

## LTE Small Cell Aggregation

- Perfect size and capacity for small cell backhauling
- Extended operating temperature range suitable for outdoor deployment
- Zero-touch provisioning helps save OPEX greatly
- High network reliability guaranteed by standard G.8032 ERPS
- Support traffic classification and prioritization
- IPv4/IPv6 for both management and services
- MLD Snooping for IPv6 multicast traffic management
- 1588v2 TC for synchronization across the network

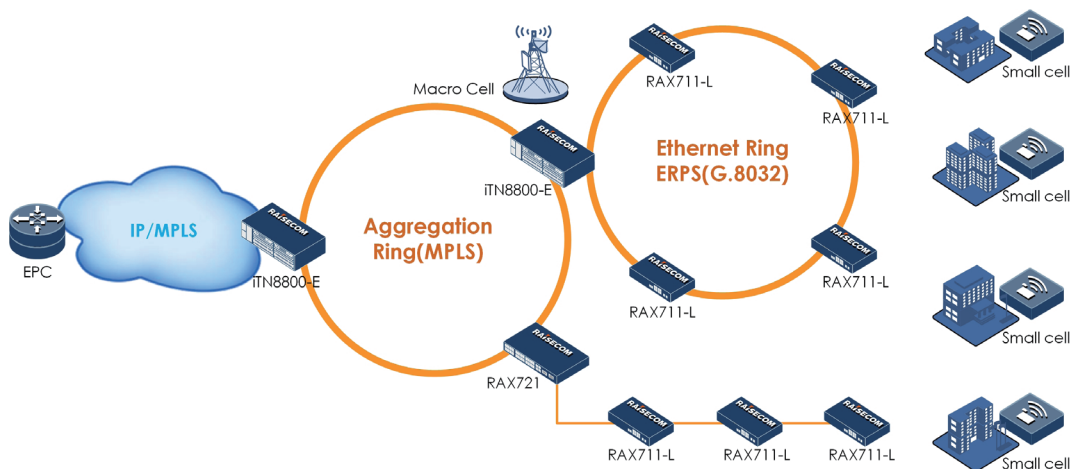



## Active WDM Solution for 4G/5G Mobile Fronthaul

- Raisecom's Fronthaul solution aid carrier to extend and enlarge radio coverage for mobile networks
- The solution lowers operational cost for carriers including rental expense, power consumption, air conditioner and site survey
- Aggregation up to 35 CPRI's per fronthaul system
- Mobile operators can benefit from the solutions by better maintenance and management of the complete wireless network

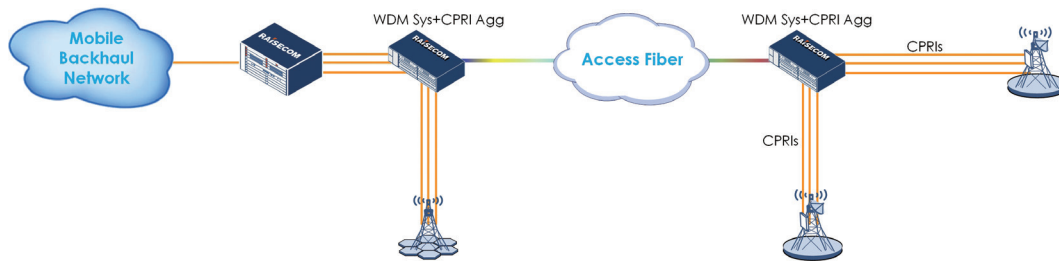

## Small Cells for Improving Mobile Coverage and Throughput

- A family of small cells for mobile operators to cost effectively improve their mobile coverage and throughput
- Integrate baseband, RF, and antenna into one, providing LTE throughput and implement full functions of a base station
- Feature intelligent SON, self-startup, automatic configuration, and flexible deployment
- Support multiple backhaul modes, such as xPON, IPRAN and Internet
- Support MIMO dual-way balancing and end monitoring
- Adopt a highly integrated chip structure with high price performance ratio

Business hall, coffee bar, bar,  
and small restaurant



Express hotel, cinema, small  
hospital, and KTV

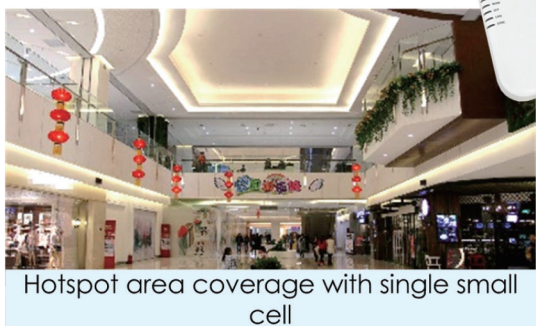

Shopping center, conference  
center, and small exhibition center



Conference center, college,  
stadium, and subway station

## Semi-Passive WDM Solution for 4G/5G Mobile Fronthaul

- Saving more fiber, 1 core can transmit 6/12 wavelength
- 1+1 line protection
- Services are not affected during power failure
- Easy deploying and maintaining to monitor the power of all channels

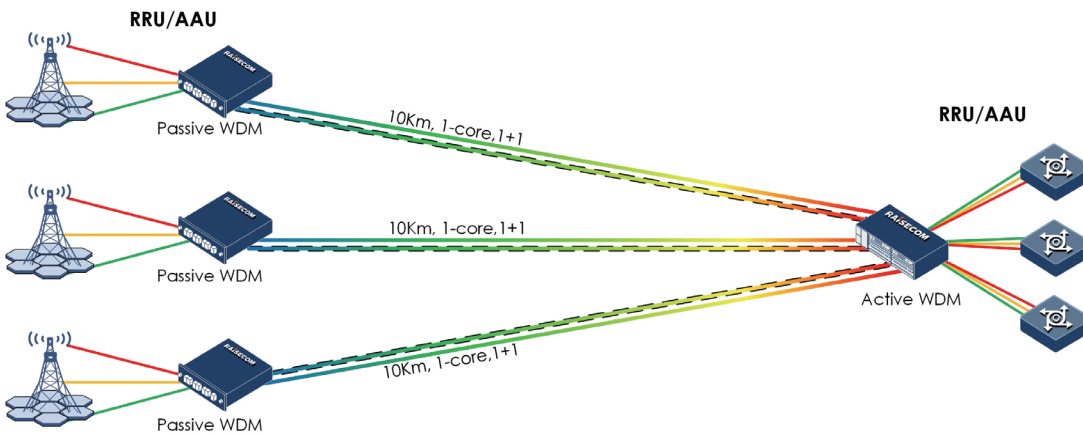

## Small Cells for Mobile Coverage in Sparsely Populated Area

- Integrate baseband, RF, and antenna into one, providing LTE throughput and implement full functions of a base station
- Support mask-mount and building-mount installation
- Feature intelligent SON, self-startup, automatic configuration, and flexible deployment
- Support multiple backhaul modes, such as xPON, IPRAN and Internet
- Support MIMO dual-antenna Rx and Tx, maximizing downlink rate
- Support AC or DC power supply options for different installation environments
- Provide a high output power, applicable for long-distance coverage in rural and mountainous areas







## Broadband Access

More and more consumers are witnessing the benefits of Fiber To The Home (FTTH) technologies. In addition to the ultra-fast internet access, these users can also benefit from triple services (Internet + Voice + Video) using the same infrastructure at reasonable costs. Some broadband service providers are now adding a fourth service (Mobile/FMC) and this increases the bandwidth usage and the need for QoS.

Raisecom offers both active Carrier Ethernet (AON-Active Optical Networks) and passive optical network (PON-Passive Optical Networks) access and aggregation solutions for high-density urban residential applications. Comprehensive streams of voice, data, video and sometimes cellular can be delivered to rural and less populated areas with low cost fiber, copper and wireless routers.

The versatile solutions enable fast deployments and pay-as-you-grow approach.

## FTTx for Rural Deployment with Full Outdoor Scenario

- Optimized solution for serving up to 1000 subscribers
- A pay-as-you-grow scalable OLT that will enable fast deployment and future growth by adding an additional 4 ports GPON line card
- All-in-one-box complete ODN, Triple play multiplexer, EDFA amplifier
- Full outdoor configuration for fast deployment
- The ISCOM5508Q-GP can provide IP67 protection level, thus meeting dustproof and waterproof requirements in the outdoor environment

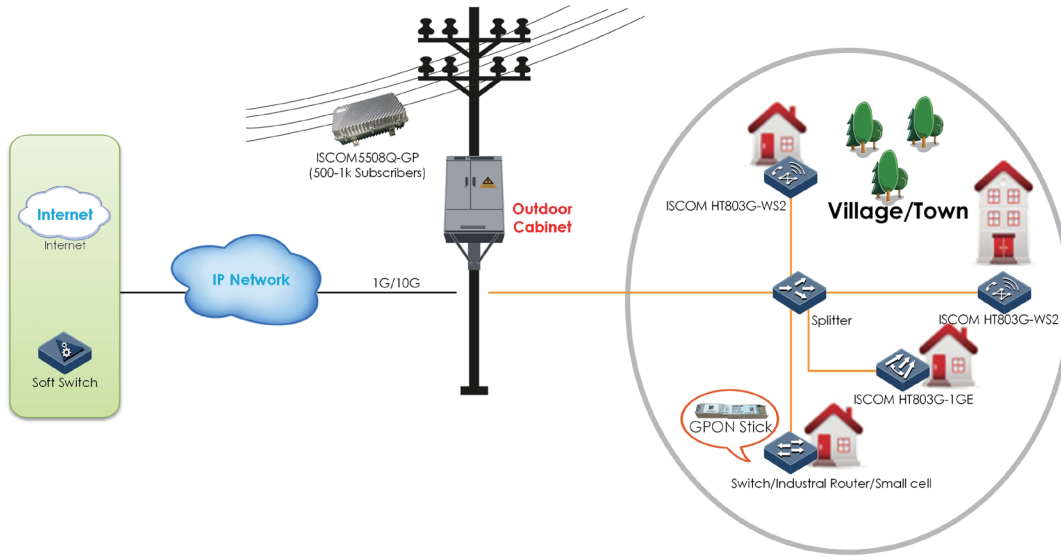

## Building A Broadband Access GPON Network for Service Providers

- Raisecom's GPON OLTs are proved to be the most cost-effective option for ISP's and Tier 2/3 deployments
- Optimized solution for a scale of 500 to 20,000 customers
- With a pay-as-you-grow approach, scalable OLT (up to 14 line cards) will enable fast deployment and future growth
- Raisecom's ONT offerings allow service providers to offer different service bundles to different users
- Carrier class network management solution can reduce provisioning cost with "Zero Touch" provisioning towards the ONT and northbound interface TL1 based on OMCI enabled auto configuration of OLT & ONT higher BSS/OSS
- Integrated with optical switch for CATV signal protection

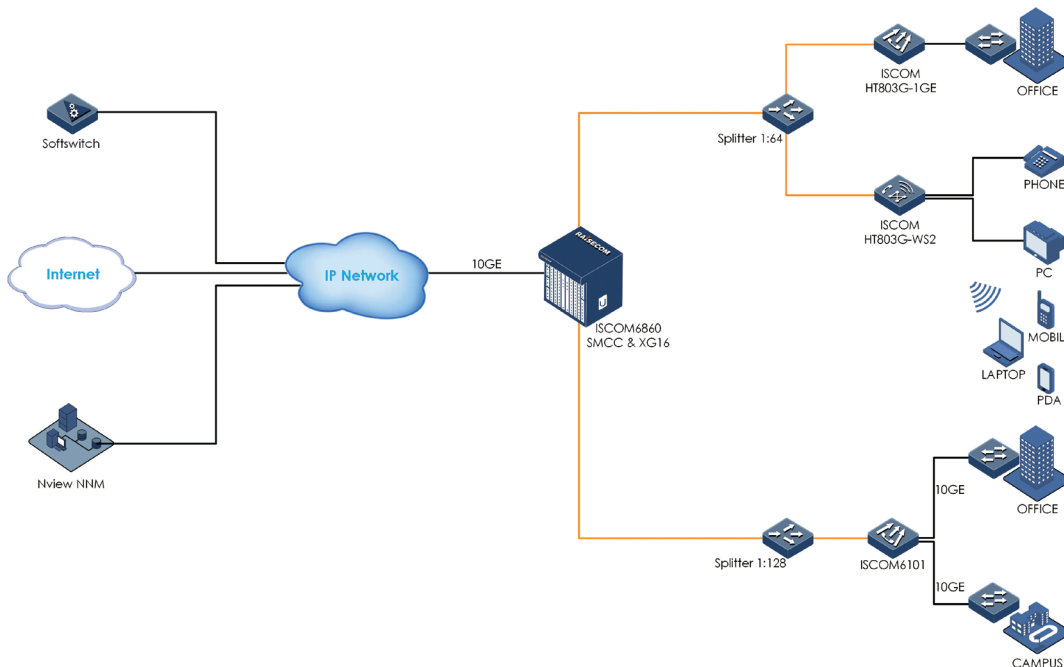



# POL All Optical Campus Network

- For regional deployments up to 4000 subscribers per chassis
- A pay-as-you-grow scalable OLT that will enable fast deployment and smooth bandwidth evolution of 10GE PON/XG/XGS PON
- Meets the needs of POL of single fiber with multiple services such as Internet, voice, video, security engineering, 5G, WIFI5, WIFI6 and IoT
- Adopts the architecture of AP(with integrated PON module)+AC to realize the wireless coverage of campus and venues
- Carrier class network management solution can reduce provisioning cost "Zero Touch" provisioning towards the ONT and northbound interface TL1 based on OMCI enabled auto configuration of OLT & ONT through BSS/OSS systems
- TR069 option enables auto configuration of ONT from ACS Server

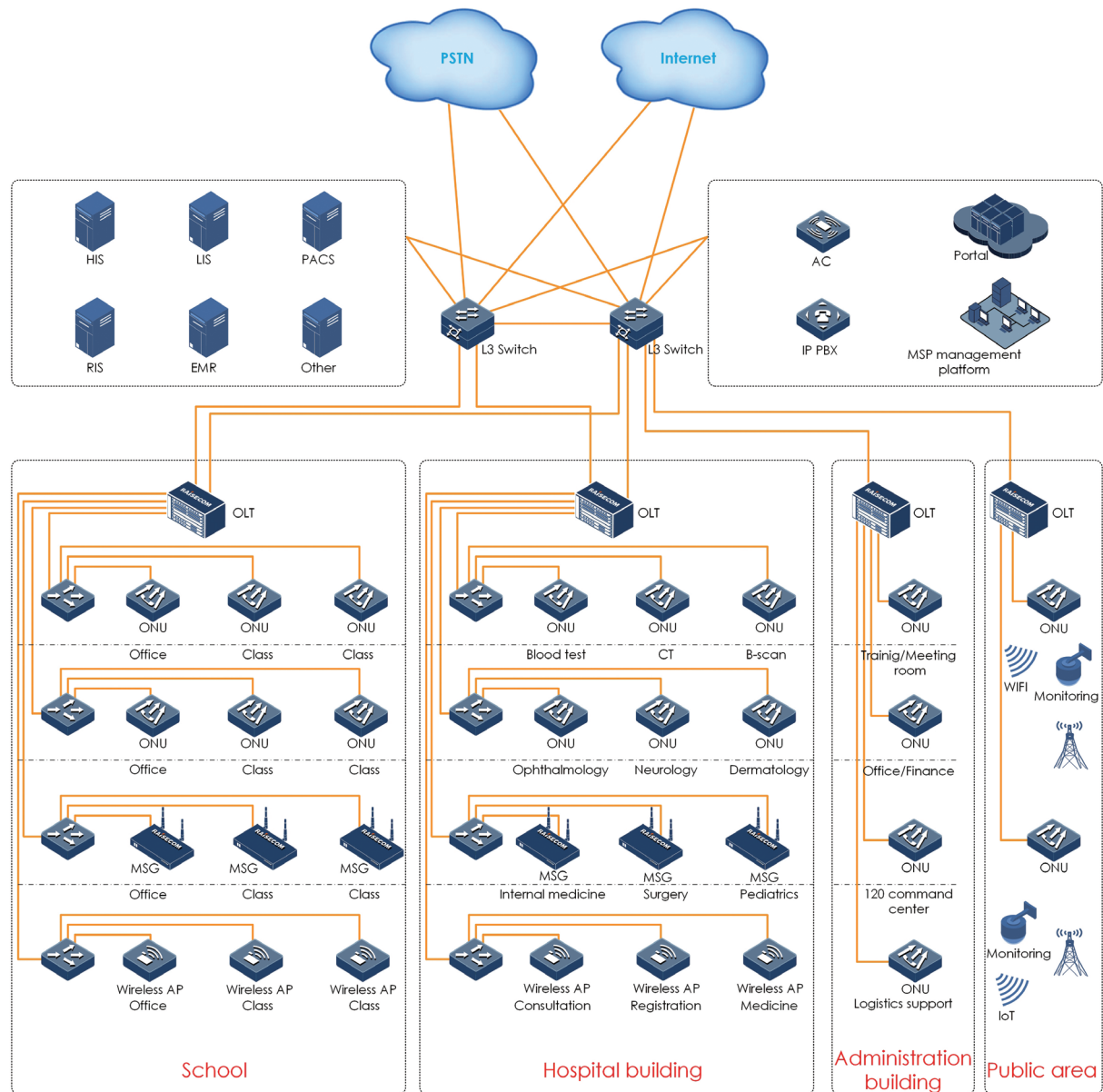

## WiFi 5/6 & G.hn Router for Smart Home Networking

- Complete smart home networking solution with Raisingcom OLT & Router, and full WiFi coverage in a house.
- Full gigabit speed with WiFi 5/6 or G.hn power line communication technology, meeting high-speed internet surfing, 4K IPTV, e-learning, VR game, etc. applications.
- Smoothly online experience for multiple people with MU-MIMO function.
- WiFi 6 router support easy mesh function for high reliability and coverage of WiFi signal.
- G.hn Router support PLC turbo, auto-pairing between base and satellite routers. PLC mesh and seamless roaming effectively ensures a high-speed home network.
- Active protection against from threats via firewall, encryption and access control function
- Unified network management via RCview, web, APP

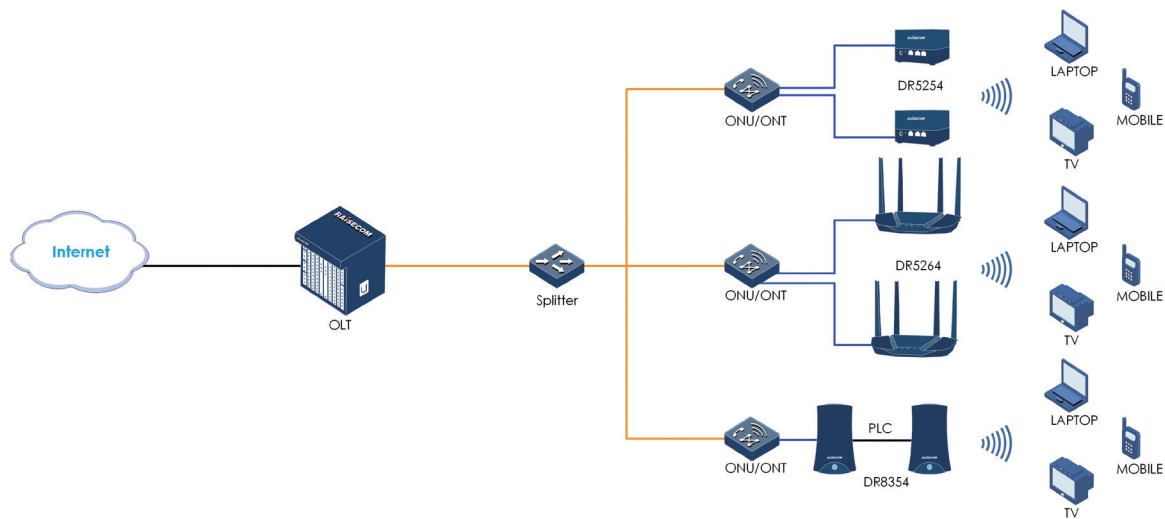



## Mission Critical Networks

Industrial and utility applications present unique challenges for network planners. First, they involve mission-critical traffic, which may be closely related to public safety and people's every-day life and requires high network reliability and resiliency. Typically, it is needed to support various types of traffic like: low-speed data communication, digital and analog voice, TDM circuits and analog control, mobile traffic, multimedia traffic, integrated surveillance and broadband access and more. In addition, the equipment must survive a wide range of environmental conditions and comply with the stringent industrial conditions.

Raisecom provides PCM connectivity solutions for SCADA traffic as well as Ethernet-based industrial products. This combination serves the broadband demands in the fields of energy (power, gas, oil, mining, and water), transportation, public information and military.

## Multi-service Access over SDH/PSN for Mission Critical Networks

- Access service types include STM-1, E1, Ethernet, EOW, FXS/FXO, E&M, Magneto Telephone, V.24, RS232, RS422, RS485, G.703, C37.94, and etc. which can cover almost all required access interface types in Mission Critical Networks
- SDH and PSN dual backplane guarantees a smooth upgrade from SDH to packet based network (Carrier Ethernet, MPLS-TP, UDP/IP) following the packetized trend
- Redundancy in power supply, cross connect matrix, switching matrix, and uplink builds up a fully redundant system with high-reliability
- Flexible clocking solutions can fit in customer's real deployment plan
- Available with 6U chassis based solution and 1.5U stand-alone solution for substations of different sizes

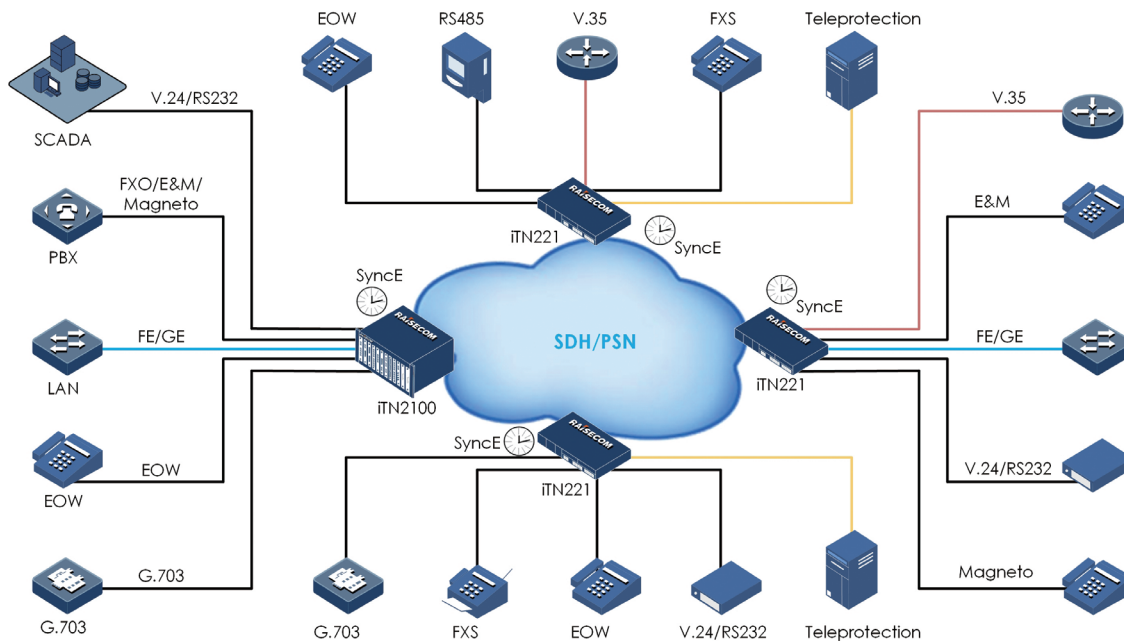



## Intelligent Environment Monitoring System for Power Distribution Unit and Oil Well

- Raisecom intelligent IoT gateways realize data collection, edge computing and data transmission in compact DIN-rail design
- Various interfaces (Ethernet, PoE, RS232/485, DI/AI/DO, ZigBee) provided greatly reduce the number of devices and connections, and the OPEX on site
- Real-time local data processing powered by high-performance ARM/x86 processor increases efficiency significantly
- Built-in development environment open for customization for industrial platform interfacing on cloud
- Fixed and 4G/5G uplink working in backup guarantees high transmission reliability
- Industrial-grade hardware design ensures stable operating in harsh environment with extreme temperature and high electromagnetic interference

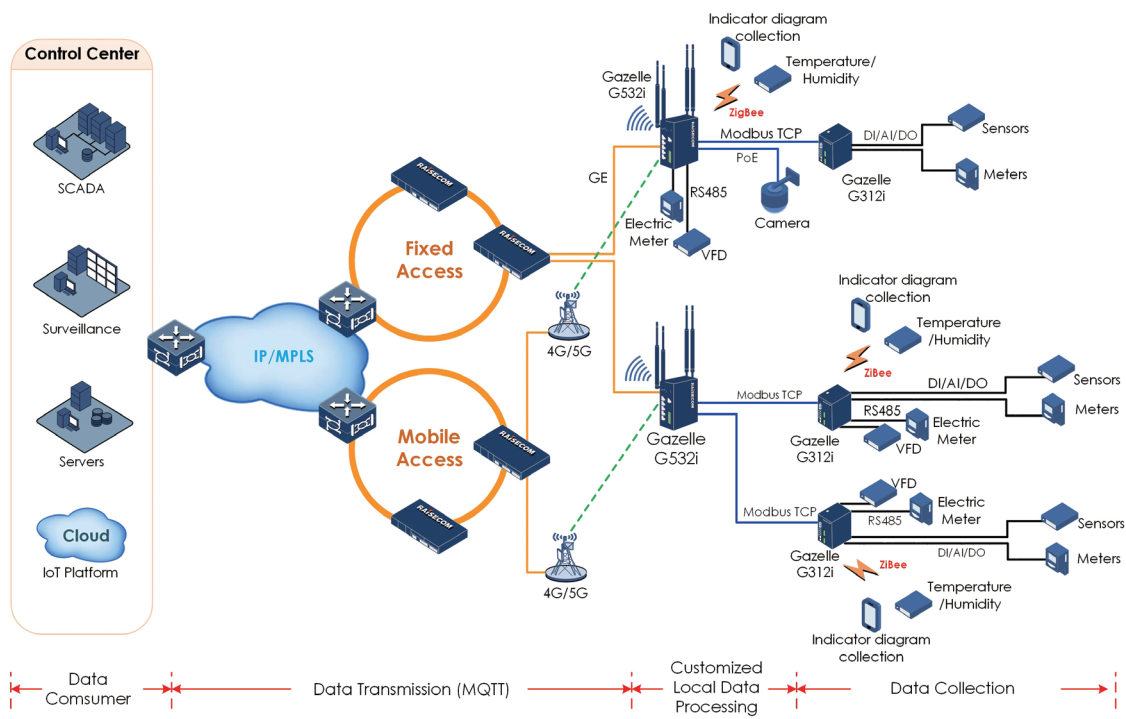



## Highway Security, Monitor and Automation

- Raisecom offers a family of industrial-grade switches to help highway operators build up communication network for their surveillance, control and toll system
- The family ranges from stand-alone aggregation switch to DIN-Rail access switches with different number of ports
- IEEE802.3af, 802.3at, 802.3bt standard PoE options can make deployment more cost-efficient
- Network topology can be ring/multiple-ring based on G.8032, chain, star and hybrid based on customer's networking infrastructure

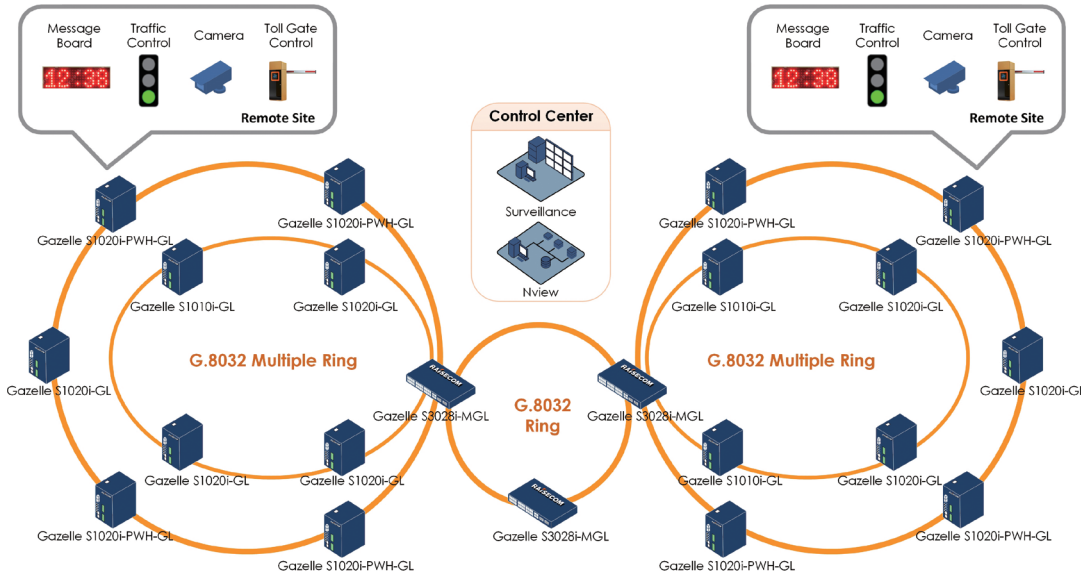

## Substation Interconnection for the Environment Monitoring System of Utilities

- Raisecom provides a family of industrial-grade switches designed in compliance with IEC61850-3
- Switches with different port capacity and different installation methods (rack-mountable and DIN-rail) are available to meet customers' real needs
- The support of G.8032 and other standards helps utility customers build a substation interconnection network with high flexibility and reliability

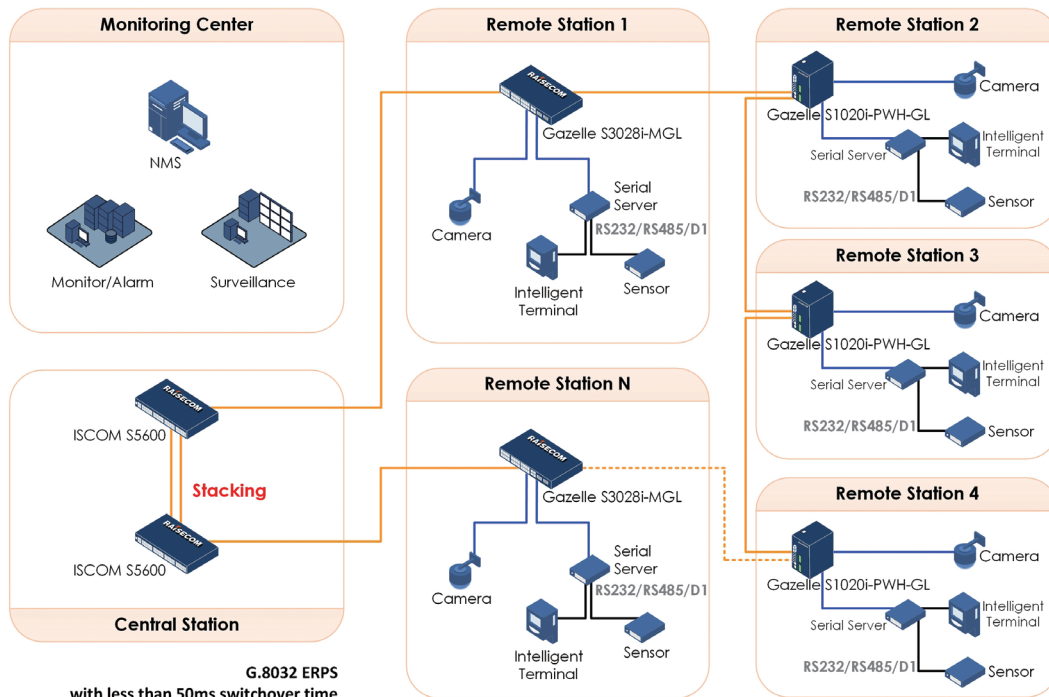



## Enterprise and Government

Small and medium size businesses create a vast marketplace for telecommunication players, by migrating their business solutions to the Internet and cloud. The required information-base is a crucial factor for SME owners to stay in the market, and requires secured, powerful and cost-effective networking.

Raisecom provides extremely cost-effective VPN access solutions for SME users that help to overcome such challenges as the lack of IT capabilities, limited budget, and the need for secured access. Raisecom solutions offer features like device integration, service integration and customer benefit maximization. These solutions assist SMEs to fully utilize private and public cloud network by combining routing, Ethernet switching, voice-support, 3G/4G backup, Wi-Fi, VPN and secure-access features in their devices.

## Safe City/Smart City Monitoring and Public WiFi Access

- Cost-efficient solutions tailored for access and aggregation network of Safe City/Smart City
- Standard IEEE802.3af, 802.3at, 802.3bt PoE options available on Ethernet ports to feed cameras and Wireless APs
- Very flexible in networking to adjust to operator/government's infrastructure topology
- Industrial-grade design and the support of rich resilience features guarantee a network with high reliability
- Ability to classify different traffic and deal with multicast traffic efficiently
- Suitable for outdoor street cabinet installation, DIN-Rail and rack-mountable options available

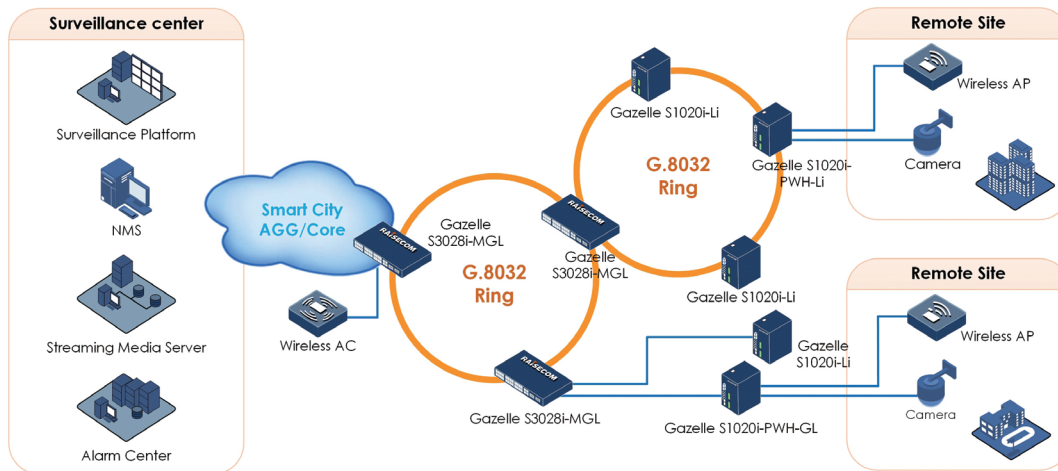

## Enterprise IoT for Advanced Factory Automation

- Raisecom offers a family of IoT gateways with industrial-grade hardware design which ensures long-term stable operation in harsh environment with wide temperature range and high electromagnetic interference
- Fixed and mobile access in backup for reliable data transmission
- Various types of interfaces (Ethernet, RS232/485, DI/AI/DO, ZigBee) available on the gateways or interface access units
- Various industrial communication protocols, like Modbus, Profibus, supported for different types of machines
- Built-in strong edge computing unit realizes data acquisition, filtering, cleaning, storage, monitoring, reporting, logic processing and other functions with customization options
- Ready to load customer-developed code to realize customized data processing requirements and to interface with dedicated IoT platform running on clouds
- Seamless interfacing to industrial applications with processed data help increase quality and efficiency of manufacturing

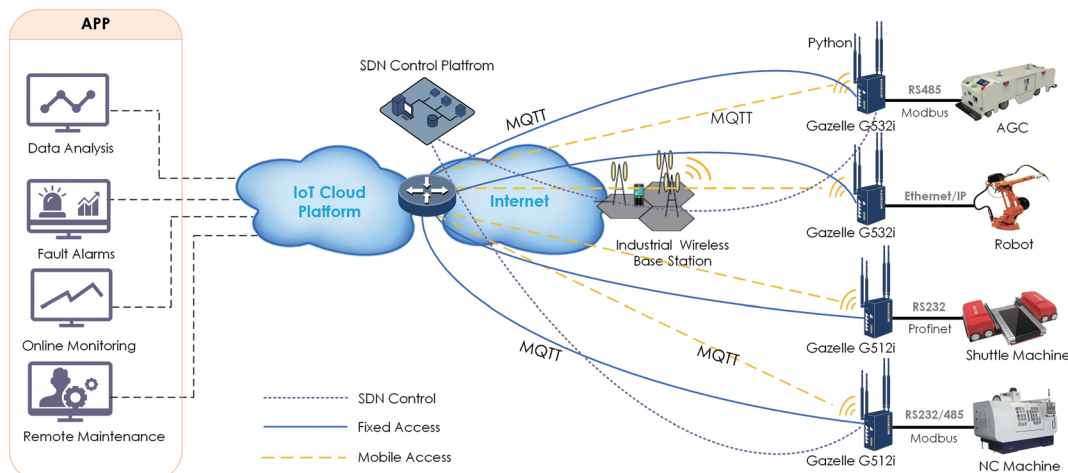

## Building Automation Field

Raisecom smart terminals access the building DCS system through customer mindsphere cloud platform. Based on the platform, it realizes various operations such as enabling, monitoring and managing smart terminals in buildings, and realizes energy optimization and intelligent control by analyzing relevant data.

- Multi-protocol collection
- Edge computing
- Storage of history data
- Safety protection
- Energy consumption perception, energy-saving
- Linkage between buildings, big data analysis
- Remote processing of faults, saving manpower

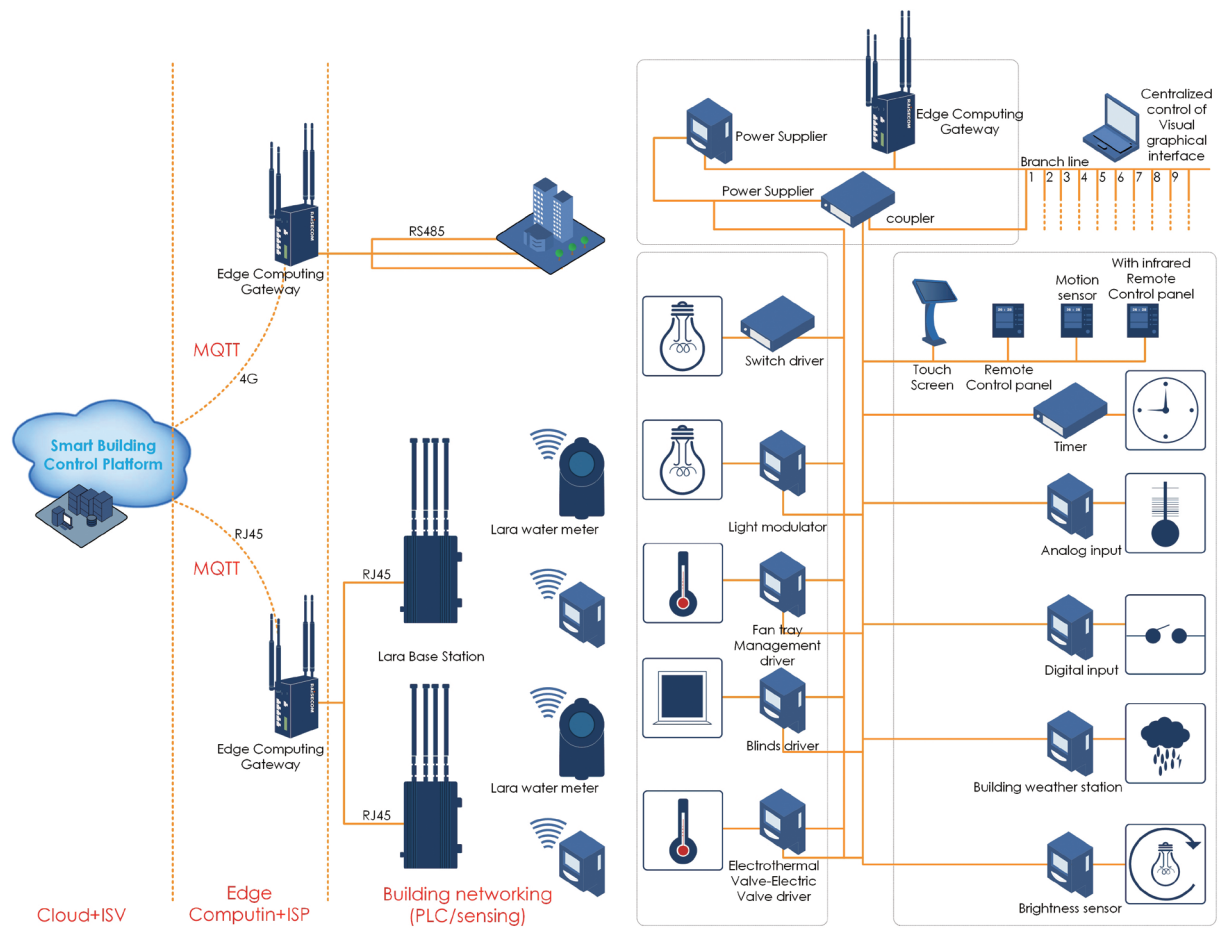





# **PRODUCT CATALOG**



# Chapter 1. Intelligent CPE

When it comes to CPEs equipment, RAISECOM is capable of providing a better range of models to comply with MEF standards, thereby deploying networks with E-Line, E-LAN, E-Tree and E-Access service. In addition to MEF modes, the product lines also can carry out L2VPN and L3VPN service. The high performance of management strategy with and end-to-end SLA ensures the quality of services, which can be clearly visible from RAISECOM Nview system. Last but not least, with the compact and redundant power supply design, RAISECOM CPEs models are very competent in leased line, wholesale and mobile backhaul applications.

## Intelligent Ethernet Demarcation Device

### RAX701-GC, RAX711-L

These intelligent Ethernet demarcation devices can be deployed for the delivery of standard E-Line, E-LAN, E-Tree, and E-Access services for large enterprises/organization and small/medium businesses, and for mobile backhaul. The very compact design makes it easy for deployment. Both RAX701-GC and RAX711-L support zero-touch provisioning and standard ITU-T Y.1564 SAT for an easy and efficient service turn-up, and they guarantee end-to-end SLA of classified services with the support of CFM and ITU-T Y.1731 SLA. All performance data are well presented on GUI. The service-based QoS helps to differentiate flows and to commit forwarding priority within each EVC. And the support of ITU-T G.8032/1 help the EDD perfectly fit in different network topologies with high reliability and flexibility.



RAX701-GC



RAX711-L

## FEATURES

- Compact hardware design
- Zero touch provisioning
- MEF CE2.0 Certified E-Line, E-LAN, E-TREE and E-Access services
- L2VPN over MPLS with MPLS-TP OAM and Protection features
- ITU-T G.8031/8032 ELPS/ERPS with sub-50ms switch-over time
- ITU-T Y.1564 SAT and RFC2544
- Hardware-based IEEE802.3ah OAM, 802.1ag CFM, Y.1731/SLA
- TWAMP light (Generator & Reflector)
- Synchronization: SYNC-E and 1588-TC
- User-friendly CLI/GUI-based management

P/N	RAX701-GC	RAX711-L
NNI Interface	2 x GE SFP	
UNI Interface	1 x GE combo	4 x GE combo
E1 PWE	N/A	4 x E1
Clocking	1588-TC	SYNC-E, 1588-TC
Dimension(mm)	180 (L) × 160 (W) × 43.6(H)	220 (L) × 180 (W) × 43.6(H)
Power	100-240V AC, -36 to -72V DC WP Full Load: ≤ 12W	100/240V AC, -36 to -72V DC, 24V DC Full Load: ≤ 25W
Working Temperature	-20~65°C	-10~55°C
MTU	12,288 Bytes	

## Intelligent 10G Ethernet Demarcation Device

### RAX711-C-R

Raisecom RAX711-C-R is an advanced 10GE IP/MPLS NID providing 4 x 10G SFP+ network interfaces and 12 x 1G SFP user interfaces in a compact-design half-19-inch wide enclosure equipped with dual redundant hot-swappable power supply modules.

The NID is designed for 1G/10G leased line service delivery and 4G/5G mobile backhauling. The support of standard CE2.0 services (E-Line, E-LAN, E-Tree, E-Access), various service models over MPLS (VPWS, VPLS, H-VPLS, L3VPN), and advanced OAM, SLA, resiliency features, ensure service providers great flexibility and reliability in service design and deployment. The device can operate in extended temperature range. And the support of SyncE and IEEE 1588v2 makes it ready for MBH application.



RAX711-C-R

## FEATURES

- Dual hot-swappable power supply with voltage/temperature monitoring
- Compact design in half-19-inch width
- Extended operating temperature range: -20°C to 65°C
- Zero-Touch provisioning
- Standard CE2.0 services and VPWS, VPLS, H-VPLS, L3VPN over MPLS
- Flexibility in traffic classification ensures customer-defined service SLA
- Full set of protection mechanisms for Ethernet, MPLS, IP services
- HW-based end-to-end SLA performance monitoring
- Multicast and multicast traffic control
- Standard RFC2544 and ITU-T Y.1564 SAT
- Synchronization: SYNC-E and 1588-TC

P/N	RAX711-C-R
NNI Interface	4 x 10GE SFP+
UNI Interface	12 x GE SFP
Clocking	SYNC-E, 1588V2-TC
Dimension(mm)	220 (L) × 266 (W) × 44(H)
Power	100/240V AC, -36 to -72V DC Full Load: ≤40W
Working Temperature	-20~65°C
MTU	12,288 Bytes

## Chapter 2. IP MPLS

IP/MPLS provider edge and customer edge products offer high performance MPLS switching & routing and effortless scalability. Raisecom brings the benefits from an MPLS core all the way to the customer premises with its IP/MPLS portfolio, delivering services with adjustable bandwidth and dedicated SLA, without increasing network complexity and expenses. Raisecom IP/MPLS solutions help service providers flexibly optimize their network loads, improve their service performance, and reduce their TCO.



## IP-MPLS Pre-Aggregation and PE Device

### iTN8800-A, iTN8800-E

iTN8800 series are chassis-based IP/MPLS service access and aggregation devices. They support service interfaces from GE/FE, 10G to 25G, 100G. These various interfaces ensure iTN8800 chassis work with Raisecom intelligent CPEs to deliver and aggregate services on unified service monitoring and management platform. The total access and aggregation solution is perfect for government/enterprise lease-line service delivery, mobile backhauling, Internet and Cloud connect, and campus networking.

iTN8800-A is a 5U-height chassis providing 14 slots for service modules. iTN8800-E is a 3U-height chassis providing 10 slots for service modules.

## FEATURES

- Modular design providing flexibility in hardware configuration
- High reliability guaranteed by dual redundant power supply modules, and dual control modules
- Various Ethernet interface cards available providing Ethernet interfaces from 1G, 10G, 25G, 40G to 100G
- IPv4/IPv6 dual-stack
- MEF CE2.0 complied E-Line, E-LAN, E-Tree, E-Access service with OAM and hardware-based SLA
- Fine-tuned QoS and HCAR
- VPWS, VPLS, H-VPLS, L3VPN over MPLS with service status and performance monitoring
- Full IGP/EGP protocol stack, RIP, OSPF, IS-IS, BGP
- Multicast traffic management by IGMP V1, V2, V3, PIM-SM, IGMP snooping, MLD v1, v2, MLD snooping
- Ethernet VPN and Segment Routing for greater network simplicity, agility and scalability\*
- SyncE and IEEE 1588v2 TC/BC for synchronization
- High network flexibility and resilience guaranteed by spanning tree protocol family, LACP, MLAG, standard ITU-T G.8031/8032
- Management security ensured by AAA and ACL
- User friendly standard SNMP-based GUI management



iTN8800-A



iTN8800-E

## System and Sub-cards

- iTN8800-A-DC: iTN8800-A chassis with fan module & 2 x DC power modules
- iTN8800-A-AC: iTN8800-A chassis with fan module and 2 x AC power modules
- iTN8800-A-NXU: iTN8800-A management & control module
- iTN8800-E-DC: iTN8800-E chassis with fan module & 2 x DC power modules
- iTN8800-E-NXU: iTN8800-E management & control module
- iTN8800-A-RC1: 1 x 100GE module (QSFP28)
- iTN8800-A-RK4: 4 x 25GE module (SFP28)
- iTN8800-A-RX4: 4 x 10GE module (SFP+)
- iTN8800-A-RG8: 8 x GE module (SFP)

P/N	iTN8800-A	iTN8800-E
Number of Slots	2 for control modules 1 for auxiliary management module 14 for service modules	2 for control modules 10 for service modules
Interface	Up to 2 x 100G/40G Up to 16 x 25G Up to 44 x 10G Up to 96 x 1G	Up to 2 x 100G/40G Up to 8 x 25G Up to 32 x 10G Up to 48 x 1G
Clocking	SYNC-E, 1588-TC/BC	SYNC-E, 1588-TC/BC
Dimension(mm)	442 (L) × 220 (W) × 222.3(H)	442 (L) × 220 (W) × 133.5(H)
Power	Modular, redundant, hot-swappable 100-240V AC, -40 to -57V DC Full Load: ≤800W	Redundant, Hot-swappable -40 to -57V DC Full Load: ≤390W
Working Temperature	-5~55°C	-5~55°C

## MPLS Pre-Aggregation Pizza-Box

### RAX721 series

RAX721 are a series of compact IP/MPLS pre-aggregation devices. They are optimized for metro access and aggregation, leased-line service delivery and multi-service aggregation. Standard CE2.0 service models, VPN over MPLS, and the support of various OAM and SLA features greatly simplify service delivery and monitoring for service providers. With the support of rich L2/L3 unicast and multicast traffic control protocols, advanced QoS and high reliability technologies based on both hardware and software, RAX721 series are very flexible and reliable service aggregators for enterprise network, campus network, and residential LAN. They are capable of delivering multiple services (Internet, VoIP, IPTV, video surveillance...) and fitting in various networking topologies. And the support of IPv4/v6 makes it a future-proof investment for the customers.

RAX721-A provides 28 x 10GE SFP+ interfaces in standard 1U 19-inch box. While RAX721-B provides 4 x 10GE SFP+ uplink interfaces and 48 x 1GE SFP downlink interfaces in standard 1U 19-inch box.



RAX721-A



RAX721-B

## FEATURES

- Compact HW design providing high port density in 1U space
- IPv4/IPv6 dual-stack
- MEF CE2.0 complied E-Line, E-LAN, E-Tree, E-Access service with OAM and hardware-based SLA
- Fine-tuned QoS and HCAR
- MPLS VPWS, VPLS, H-VPLS, L3VPN with service status and performance monitoring
- Full IGP/EGP protocol stack, RIP, OSPF, IS-IS, BGP
- Multicast traffic management by IGMP V1, V2, V3, PIM-SM, IGMP snooping, MLD
- Ethernet VPN and Segment Routing for greater network simplicity, agility and scalability
- High reliability guaranteed by redundant power supply, dual system, spanning tree protocol family, LACP, MCLAG, standard ITU-T G.8031/8032
- Zero-Touch provisioning
- Management security ensured by AAA and ACL
- User friendly standard SNMP-based GUI management

P/N	RAX721-A	RAX721-B
NNI Interface	4 x 10GE SFP+	4 x 10GE SFP+
UNI Interface	24 x 10GE SFP+	48 x 1GE SFP+
Dimension(mm)	360 (L) x 440 (W) x 44(H)	
Power	Dual redundant, Hot-swappable 100-240V AC, -36 to -72V DC	
Working Temperature	-5~55°C	

## Chapter 3. Optical Transport Network

OTN (Optical Transport Network) systems smoothly handle ever-increasing bandwidth demands for data services and also for mobile backhaul, Fronthaul, Inter datacenter connectivity and GPON/EPON extension. They do so by integrating the functionality of transport, multiplexing, switching, protection and management of customer traffic in a single box. Compact OTN systems easily meet the high bandwidth demands of public and private clouds as well as software-defined networks, that require gigabit Ethernet and above. For FTTH and LTE/4G applications, OTN systems allow carriers to save on OPEX and fiber resources when deploying mobile Fronthaul and GPON/EPON.

## Multi-Service OTN Platform

### iTN8600-A

The iTN8600-A is a new generation of intelligent transmission device developed independently by Raisecom, which is a full-service access transmission platform dominated by key account service and high bandwidth integrated service. iTN8600-A is aimed at accessing/aggregation layer of MAN, which is particularly suitable for MAN demarcation of leased line service and OTN accessing. The iTN8600-A can be used for constructing high-quality leased line accessing integrated solution with iTN8600-II and iTN8607. The multiple services access at the customer premise and meanwhile realize service distribution and transmission by uplink to SDH, PTN, OTN. iTN8600 series products adopt sub-card or standalone accessing OTN devices to cover both CPE and PE application perfectly.



iTN8600-A

## FEATURES

- iTN8600-A is a 5U chassis supporting 2 NMS cards, up to 15 service cards, 2 power supply cards and 1 fan
- iTN8600-A has a high integrated device with front outlet design and supports sub-card hot swapping, -48VDC power supply, 1+1 power supply protection
- Flexible access to STM-1/4/16/64, OC-192, FE/GE, 10GE, FC 1G/2G/4G/8G/10G, OTU1/OTU2, etc.
- Support EOS, ETH over OTN, SDH over OTN, EOS over OTN, MPLS-TP over OTN, MPLS-TP, etc. service encryption
- Packets switching capability: 300G
- Support 96 × GE access, 44 × 10GE access
- Up to 57.5G cross-connection based on SDH VC4, up to 10G cross-connection based on VC12/VC3
- Max. STM1/4 access up to 104, Max. EOS access up to 104 FE/GE
- Hybrid encryption and scheduling capabilities from SDH/PKT/ODUK to OTN
- Support real-time DM delay measurement for PM and TCM

## System and Sub-cards

### NMS switching card

- iTN8600-A-NXU: iTN8600-A NMS switching card
- iTN8600-A-NTU: iTN8600-A NMS card
- iTN8600-AUX: Auxiliary interface card, used in cooperation with the iTN8600-A-NXU

### OTN card

- iTN8600-AO2DE: 8-way ANY service aggregation OTU2 card
- iTN8600-MX2: 2-way OTU2 line card
- iTN8600-A-MX4: 4-way OTU2 line card
- iTN8600-XD2D: 2-way 10GE service OTN forwarding card

### PTN card

- iTN8600-A-PG8: 8-way GE service interface card
- iTN8600-A-PX4: 4-way 10GE service interface card

### SDH card

- iTN8600-A-SH2: The aggregation card supports multiple interface modes: 2 STM-16 interfaces; 4 STM-4 interfaces; 1 STM-16 interface and 2 STM-4 interfaces, SDH services can be accessed to the OTN through backplane
- iTN8600-A-SH2A: The aggregation card supports multiple interface modes: 2 STM-16 interfaces; 4 STM-4 interfaces; 1 STM-16 interface and 2 STM-4 interfaces. SDH services can be accessed to the OTN through backplane
- iTN8600-SG8: 8-way FE EOS tributary card
- iTN8600-A-SG8D: 8-way GE EOS tributary card
- iTN8600-SS8: 8-way STM-1/STM-4 tributary card

### Optical card

- iTN8600-DM16E: 16-wavelength DWDM multiplexing card
- iTN8600-DMU40: 40-wavelength DWDM multiplexing card
- iTN8600-DD16E: 16-wavelength DWDM demultiplexing card
- iTN8600-DDU40: 40-wavelength DWDM demultiplexing card

- iTN8600-OMD8: 8-wavelength CWDM multiplexing and demultiplexing card
- iTN8600-DAD4D: DWDM 4-way dual-fiber bidirectional optical add/drop multiplexing card
- iTN8600-DAD8: DWDM 8-way dual-fiber unidirectional optical add/drop multiplexing card
- iTN8600-FDU: 2-way OSC multiplexing card
- iTN8600-OLP: Optical line 1+1 protection card
- iTN8600-OTU5E: 5-way enhanced bidirectional wavelength conversion card
- iTN8600-OPA: EDFA optical Pre-amplifier card
- iTN8600-OBA: EDFA optical Booster amplifier card
- iTN8600-OBA20: EDFA optical Booster amplifier card
- iTN8600-OLA20: EDFA optical Line amplifier card
- iTN8600-OCM: OTDR fiber detection card

#### PON aggregation card

- iTN8600-LEO2D: 8-way OLT-side EPON aggregation card
- iTN8600-LGO2D: 8-way OLT-side GPON/EPON aggregation card
- iTN8600-NO2D: 8-way ONT/ONU-side GPON/EPON aggregation card

## Compact Multi-Service OTN Platform

### iTN8600-II

The iTN8600-II is a new intelligent all-service access and transmission platform designed to future-proof networks. The iTN8600 series integrates OTN cross connection, MPLS-TP and SDH features and provides integrated all-service access, and flexible multi-core cross connection and scheduling. Operators can use it to transport multiple types of services on one platform, including leased line, FTTX, and LTE services. Altogether, it provides a complete solution for MAN access and aggregation.

The iTN8600 is perfect for mobile fronthaul, enabling mobile operators aiming to minimize OPEX and expand radio coverage. It allows carriers to multiplex up to 30 2/3/4G CPRIs and extend reach to over 25km.

An advanced new chip multiplexes 8 x EPON or 4 x GPON OLT ports into OTU2, and that traffic can be transmitted over a WDM or OTN network over 45km to extend GPON/EPON coverage and to save up to 90% of fiber. Compatible with Raisecom's RAX series products, iTN8600 can be deployed in a point to point and ring topology for various applications. It is commonly used for service provider OTN edge aggregation, mobile backhaul and fronthaul, data center interconnect as well as high capacity business connectivity. The product can be managed by a GUI-based NView NNM system to simplify configuration and monitor performance in real-time.



iTN8600-II

## FEATURES

- Universal switching and flexible grooming for OTN, SDH, and packet services
- All service access capability, including E1, STM1/4/16/64, OC-192, FE/GE, 10GE, OTU1/OTU2, CPRI, OBSAI, FC-1G/2G/4G/8G/10G, EPON/GPON, etc.
- Maximum DWDM 40λ x 10G Line capacity
- 120G packet switching capability
- All service access capability, including E1, STM1/4/16/64, OC-3/12/48/192, FE/GE, 10GE LAN, 10GE WAN and OTU1/OTU2, CPRI/OBSAI, FC-1/2/4/8/10, EPON/GPON, etc.
- EP-Line, EVP-Line, EP-Tree, EVP-Tree, EP-LAN, EVP-LAN
- MPLS-TP
- Static LSP, L2VPN and VPLS
- Up to 20G cross-connection based on VC4 or 10G cross-connection based on VC3/VC12
- G.8113.1 OAM, 802.1ag/Y.1731/SLA OAM and 802.3ah OAM
- 8 x 1.25G over OTU2 and 4 x 2.5G over OTU2 multiplexer
- Transponder with 5 OTU2 ports on each card
- System management card and power supply module redundancy
- Support Auto Laser Shutdown (ALS) protection and Dying Gasp
- Redundancy and reliability with one plus one OCh and SNCP on OTN side, ITU-T G.8031 (ELPS), G.8032 (ERPS) and LAG protection on Ethernet side, MPLS-TP G.8131 LSP/PW 1:1-protection on PTN side and 1+1 MSP, SNCP, on SDH side
- via in-band and out-of-band network channels

## System and Sub-cards

### Chassis and NMS cards

- iTN8000-II-DC, 2U/11 slot chassis
- iTN8600-II-NXU, system management and control card for iTN8600-II chassis
- iTN8600-II-NTU, optical system management and control card for iTN8600-II chassis

### OTN card

- iTN8600-AO2DE: 8-way ANY service aggregation OTU2 card
- iTN8600-XD2D: 2-way 10G service OTN forwarding card

### PTN card

- iTN8600-PG8: 8-way GE service interface card
- iTN8600-PX2: 2-way 10GE service interface card
- iTN8600-PE16-BL: 16-way balanced E1 CES card

### SDH card

- iTN8600-SH2: 2-way STM-16 aggregation card
- iTN8600-SG16: 8/16-way FE/GE EOS card
- iTN8600-SS4: 4-way STM-1/4 tributary card

### Clock card

- iTN8600-TAU: iTN8600 time processing card

### Optical card

- iTN8600-DM16E: 16-wavelength DWDM multiplexing card
- iTN8600-DMU40: 40-wavelength DWDM multiplexing card
- iTN8600-DD16E1: 6-wavelength DWDM demultiplexing card
- iTN8600-DDU40: 40-wavelength DWDM demultiplexing card
- iTN8600-OMD8: 8-wavelength CWDM multiplexing and demultiplexing card
- iTN8600-DAD4D: DWDM 4-way dual-fiber bidirectional optical add/drop multiplexing card
- iTN8600-DAD8: DWDM 8-way dual-fiber unidirectional optical add/drop multiplexing card
- iTN8600-FDU: 2-way OSC multiplexing card
- iTN8600-OLP: Optical line 1+1 protection card
- iTN8600-OTU5E: 5-way enhanced bidirectional wavelength conversion card
- iTN8600-OPA: EDFA optical Pre-amplifier card
- iTN8600-OBA: EDFA optical Booster amplifier card
- iTN8600-OBA20: EDFA optical Booster amplifier card
- iTN8600-OLA20: EDFA optical Line amplifier card
- iTN8600-OPD: 10-way optical power detection card
- iTN8600-OCM: OTDR fiber detection card

### PON aggregation card

- iTN8600-LEO2D: 8-way OLT-side EPON aggregation card
- iTN8600-LGO2D: 8-side OLT GPON/EPON aggregation card
- iTN8600-NO2D: 8-side ONU-side GPON/EPON aggregation card



## Standalone Multi-Service OTN Platform

### iTN8600 Series pizza box

iTN8600 pizza box is a 1U, 19-inch multi-service access device, it can access STM1/4/16/64, FE/GE, 10GE, OTU1/OTU2, CPRI, OBSAI, FC-1G/2G/4G/8G/10G, and EPON/GPON services. It includes iTN8607 series standalone OTN devices, iTN8601 series standalone WDM devices, and iTN8605 series standalone PON aggregation devices.

iTN8601 can access 4 x 10G, 1 x 2.5G services to 1-core optical fiber transmission, easy to deploy and maintain. It used to expand fiber capacity at the access layer and to solve the problem of scarce channels in cities and inadequate end-to-end fiber resources.

iTN8605 can access 8 x GPON/EPON aggregation to 1/2 OTU2 transmission, it is used in cooperation with the iTN8600. Oriented towards access optical fiber layer between the OLT and optical splitter, it aggregates and transmits signals of multi-core fiber optical cables with the same route between the OLT and optical splitter.

iTN8607 can access STM1/4, FE/GE/10GE services to OTU2 transmission, support OTU2 1+1 protection, easy to deploy and maintain. Can be used in Data Center Interconnection, OTN leased line and other application scenarios.



iTN8601-OTM4



iTN8601-OTMx



iTN8605-NO2D



iTN8607-OG8C



iTN8607-OX1



iTN8607-B-OG6S2

## FEATURES

### Standalone OTN:

- iTN8607-OG8C: 1U, 19", Compact OTN multiplexing device, client side interface: 8 x GE/FE, line side interface: 2 x OTU2, support 1+1 protection
- iTN8607-OX1: 1U, 19", Compact OTN multiplexing device, client side interface: 2 x 10GE, line side interface: 2 x OTU2, support 1+1 protection
- iTN8607-OA8: 1U, 19", Compact OTN multiplexing device, client side interface: 8 x FE/GE/STM-1/STM-4, line side interface: 2 x OTU2, support 1+1 protection
- iTN8607-OA2: 1U, 19", Compact OTN multiplexing device, client side interface: 2 x FE/GE/STM-1/STM-4, line side interface: 2 x OTU1, support 1+1 protection

### Standalone WDM:

- iTN8601-OTM4-SL: 1U, 19", Compact WDM device, 30km short distance left, client side interface: 4\*any interfaces (1.25Gbit/s~11.3Gbit/s), line side only one core fiber; SL and SR must be paired to use
- iTN8601-OTM4-SR: 1U, 19", Compact WDM device, 30km short distance right, client side interface: 4\*any interfaces (1.25Gbit/s~11.3Gbit/s), line side only one core fiber; SL and SR must be paired to use
- iTN8601-OTM4-LL: 1U, 19", Compact WDM device, 60km short distance left, client side interface: 4\*any interfaces (1.25Gbit/s~11.3Gbit/s), line side only one core fiber; SL and SR must be paired to use
- iTN8601-OTM4-LR: 1U, 19", Compact WDM device, 60km short distance right, client side interface: 4\*any interfaces (1.25Gbit/s~11.3Gbit/s), line side only one core fiber; SL and SR must be paired to use
- iTN8601-OTMx-SL: 1U, 19", Compact WDM device, 30km short distance left, support a total of 5 ways (4 x 10G + 1 x 2.5G) service through single fiber bi-directional transmission. The service rate of each way is backward compatible to FE, line side only one core fiber; SL and SR must be paired to use
- iTN8601-OTMx-SR: 1U, 19", Compact WDM device, 30km short distance right, support a total of 5 ways (4 x 10G + 1 x 2.5G) service through single fiber bi-directional transmission. The service rate of each way is backward compatible to FE, line side only one core fiber; SL and SR must be paired to use.

### Standalone PON aggregation:

- iTN8605-NO2D: 1U, 19", 8-way ONU-side GPON/EPON aggregation compact device, must be paired with iTN8600-LGO2D/LEO2D card

## OTN 100G/200G Standalone Device

### iTN8600-I-XT4D

iTN8600-I 100G Pizza Box is high density 1U 19-inch 100G OTN standalone Transponder/Muxponder. By adopting advanced technology and ASIC chip, it is fully compliant with ITU-T standard, such as G.709, G.798, etc. iTN8600-I 100G Pizza Box device is suitable for datacenter interconnection, metro access and metro aggregation optical transport network. It is convenient to be managed by NMS system via SNMP.

## FEATURES

- 1U, 19-inch standalone device
- Dual 110V/220V AC or Dual-48V DC redundancy power supply
- Support SFP+, SFP28 40G QSFP+ or 100G QSFP28 in client side
- Support 100/200G Coherent CFP2 or 100G Grey CFP2 ER4/LR4 on line side
- Support GFEC and SD-FEC (Soft-decision FEC) on line port
- Support encrypted transmission on the client side and line side
- Support GCC0, GCC1 and GCC2 In-band DCN Management
- Support SNMP for Out-of-band DCN Management



iTN8600-I-XT4D

P/N	iTN8600-I-XT4D
Line interface	2 x CFP2 based 100G port (coherent CFP2, grey CFP2 ER4/LR4) or 1 x CFP2 based 200G port (coherent CFP2) Support GFEC and SD-FEC
Client interface	2 x 100G (100GE, OTU4 -QSFP28) 20 x 10G (10GE LAN/WAN, STM-64, 8G FC/10G FC, OTU2(e)-12 x SFP +s and 2 x (QSFP+s) 12 x 10G Any (SFP+) + 2 x 40GE (QSFP+) 12 x 16G FC (SFP+) 6 x 32G FC (SFP28)
Power Supply	AC: Input 100–240V, DC: Input -40 to -57V
Power Consumption	<150W
Dimension(mm)	440(L) x 360(W) x 45(H)
Operation Temperature	General: -5°C ~ 50°C

## WDM Semi-Passive Device

### OPCOM100-SA

Raisecom WDM Semi-Passive devices, including Central Office (CO) devices and remote devices. OPCOM100-SA CO devices are 2U chassis, include the OPCOM100-SA chassis, OPCOM100-SA-NMU network management card, and OPCOM100-CPM active single-fiber bidirectional 6/12-wavelength channels CWDM protective multiplexing card. The OPCOM100-OMU6-P or OPCOM100-OMU12-P remote card is a 1U-high, passive, single-fiber bidirectional, 6/12-wavelength channels CWDM protective multiplexer/demultiplexer. It can be installed separately or in a plug-in encapsulation box, such as the PB3/PB16.

WDM Semi-Passive devices, mainly used for 4G/5G wireless fronthaul optical fiber capacity expansion, unilateral wavelength conversion, and Semi-Passive CWDM private line access.



OPCOM100-SA

## FEATURES

- WDM semi-passive, flexible deployment. Local side device is active, and remote device is passive
- Manageable and maintainable
- 1-core fiber for bidirectional services
- Line side 1+1 protection
- Uninterrupted services during power failure
- 4G/5G/Mixed access, saving fiber resources

# Chapter 4. xPON

GPON & EPON networks provide high throughput point-to-multipoint connections from the Point of Presence (POP) to the customer premise. It can be profitably used in massive deployments of triple-play services as it offers a low CAPEX and OPEX. It is also possible to optimize TCO when fiber resources are limited, by deploying point-to-point active optical networks. The Raisecom xPON product line supports both the EPON and 10GEPON technologies introduced by IEEE, as well as the GPON/XGSPON technologies introduced by ITU. The former offers a GE or 10G symmetric bit rate, while the latter offers symmetric/asymmetric 2.5GE/10G downstream and 1.25GE/10GE upstream bit rates.

A strong portfolio of RAISECOM GPON/EPON products cover an enormous variety of equipment so that the central side equipment from the rack-mounted OLTs with high and low densities models to standalone chassis models can work well with related ONTs which can be divided into single family units (SFU) and multi-dwelling units (MDU) to meet the needs. In addition to product form design, RAISECOM also differentiates one variety from another according to application scenarios. Low density models serve rural and suburban areas, while those with high density are competent to urban project deployment. All RAISECOM solutions are premised on the basis of scalability, PON system which acts according to local conditions when deploying is responsible for the transmission of native Ethernet services from backbones to "Last Mile". Having good performance on provision, remote management and network redundancy achieves a profitable business mode in FTTX deployment project.

## xPON OLT

### ISCOM6800

ISCOM6800 is a 13U high-density integrated platform compatible with both IEEE802.3ah EPON and ITU-T G.984 GPON as well as IEEE 802.3av 10G EPON standards. The system can aggregate a maximum of 28,672 ONU/ONTs with a typical 1:64/1:128 split ratio. ISCOM6800 also possesses great switching capacities and can be used to aggregate and transport data, voice and video traffic from other OLTs over Ethernet backbones. Enhanced network manageability, reliability and redundancy are supported with ring protection mechanisms and a hot-swappable redundant power supply. ISCOM6800 also supports multi-purpose access and aggregation PON Ethernet traffic at the same time.

## FEATURES

- Available with mixed pluggable up to 224 x GE or 72 x 10GE interfaces for uplink/switching
- Up to 224 x GPON/EPON interfaces for downlink
- Up to 112 x 10GEPON interfaces for downlink
- 2 x SMC control module supporting real-time redundancy
- Up to 1:64/1:128 split ratio, and 28,672 ONU/ONTs per full-load 10U OLT chassis
- IEEE 802.3ah (EPON), ITU-T G.984 (GPON), IEEE 802.3av (10G EPON)
- Storm control of broadcast, multicast and DLF
- Trunk group and Link Aggregation Control Protocol (LACP)
- 1+1 automatic protection and link diagnostic for each PON port
- VLAN, QinQ, QoS, DBA
- IGMP, Multicast VLAN Registration (MVR), DHCP and Option 82
- Routing of IPV4/IPV6, RIP, OSPF, ISIS, BGP (ISCOM6800-SMCC only)
- AES-128 encryption and triple churning
- Hot-swappable redundant power supply
- CLI, Telnet, SSHv2 and SNMP (NView compatible)



ISCOM6800

## System and Sub-cards

- ISCOM6800-18-A, 13U/18-slot chassis with an airflow slot and only a cable array
- ISCOM6800-SMCA, Switching and control card, working in slot 9 or 10. 1 Console interface (RJ45) for local management and 1 SNMP out-of-band management interface (RJ45)
- ISCOM6800-SMCC\*, L3 Switching and control card, working in slot 9 or 10. 1 Console interface (RJ45) for local management and 1 SNMP out-of-band management interface (RJ45)
- ISCOM6800-EP16, GEAPON line card, 16 x GEAPON SFP ports, working in slot1-8 and slot 11-16
- ISCOM6800-XEP8\*, 10G EPON line card, 8 x 10GEAPON SFP+ ports, working in slot1-8 and slot 11-16
- ISCOM6800-XP4L, 10GE card, 4 x 10GE SFP+ ports, working in slot1-8 and slot 11-16
- ISCOM6800-GP16, GPON line card, 16 x GPON SFP ports, working in slot 1-8 and slot 11-16
- ISCOM6800-XP4A, 10GE card, 4 x 10GE SFP+ ports, working in slot 19 or 20
- ISCOM6800-GE16, GE card, 16 x GE SFP ports, working in slot 1-8 and slot 11-16
- ISCOM6800-XP2A, 10GE card, 2 x 10GE SFP+ ports, working in slot 19 or 20

## Medium xPON OLT

### ISCOM6860

The ISCOM6860 is a high-density carrier-grade Optical Line Terminal (OLT) platform. It offers EPON, 10G EPON, GPON, XGS-PON and leased line access, as well as multi-service aggregation capabilities.

The ISCOM6860 is equipped with high backplane bandwidth of 2.88 Tbit/s, high switching capacity of 1.44 Tbit/s, and 1:1 switching redundancy for wire-rate non-blocking forwarding and high reliability for all services. It can provide high-density PON interfaces and mount up to 14336 ONUs to meet the carrier's need for high-capacity with fewer offices. Cards and fans adopt green energy-saving design to lower power consumption and emissions.

The ISCOM6860 is perfect for POL, FTTx, HFC bidirectional transformation, mobile backhaul, IP leased line interconnections, and more applications.

## FEATURES

- Support Layer 2 and Layer 3 wire-speed forwarding
- Support up to 112 GPON/XGS-PON/EPON interfaces for downlink
- Support up to 56 10GEAPON interfaces for downlink
- Support broadband, voice, IPTV, etc. access services to meet the varying needs of carriers, broadcast, radio, television network, and customer premise networks
- Support 1:1 protection of SMCs, 1+1 redundancy of power supplies, and hot pluggable of all cards
- Carrier-grade PON protection of type B/C/D
- Raisecom private Ethernet ring topology with switching time of 50ms
- VLAN, including selective QinQ, VLAN mapping and aggregation
- Complete QoS, including dynamic assignment of bandwidth, priority control, multiple traffic classification modes, multiple queue scheduling modes, etc. to meet different QoS requirements for VoIP, video, and Internet access services
- Complete ACL, including L2, L3, L4, and customized ACLs
- MSTP, link aggregation, DHCP, interface isolation, etc
- Layer 2 multicast, IGMP Snooping, Proxy, MVR, and controllable multicast
- IPv4/v6 unicast routing, RIP, OSPF, ISIS, BGP (ISCOM6800-SMCC only)
- With a low power consumption design for all cards, overall power consumption is below 1000W
- An intelligent fan with automatic speed adjustment according to chassis temperature prolongs life of fan, reduces noise, and saves energy
- Can power off the PON service card and uplink card to conserve energy

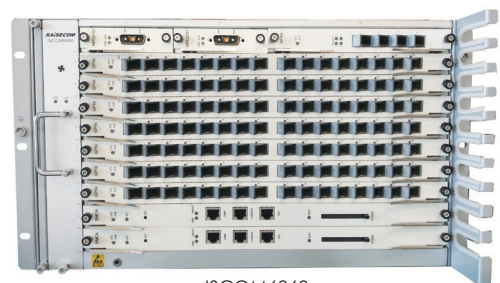

ISCOM6860

## System and Sub-cards

- ISCOM6860-10, ISCOM6860 chassis. (without Fan)
- ISCOM6860-10-FANS381, intelligent FAN. (only for ISCOM6860)
- ISCOM6800-SMCA, switching and control card, working in slot 1 & 2. 1 Console interface (RJ45) for local management and 1 SNMP out-of-band management interface(RJ45)
- ISCOM6800-SMCC\*, L3 switching and control card, working in slot 1 & 2. 1 Console interface (RJ45) for local management and 1 SNMP out-of-band management interface (RJ45)
- ISCOM6800-EP16, GEAPON line card, 16 x GEAPON SFP ports, working in slots 3-9. (without SFP modules)
- ISCOM6800-XEP8, 10GEAPON line card, 8 x 10GEAPON SFP+ ports, working in slots 3-9. (without SFP modules) Note: Only MDU (6104/6116/6124) type ONT with 10GEAPON interface
- ISCOM6800-XG16\*, 10G XGS-PON line card, 16 x 10G XGS-PON ports, working in slots 3-9. (without SFP modules)
- ISCOM6800-GP16, GPON line card, 16 x GPON SFP ports, working in slots 3-9. (without SFP modules)
- ISCOM6800-GE16, GE card, 16 x GE SFP ports, working in slots 3-9. (without SFP modules)
- ISCOM6800-XP4A, 10GE card, 4 x 10GE SFP+ ports, working in slot 10. (without SFP modules)
- ISCOM6800-XP2A, 10GE card, 2 x 10GE SFP+ ports, working in slot 10. (without SFP modules)
- ISCOM6800-XP4L, 10GE card, 4 x 10GE SFP+ ports, working in slot 3-9. (without SFP modules)
- RPA2161-S-220S54, 1U, 19" mountable rack. AC/DC embedded power system supplying -48VDC voltage output. It can be configured by one to two rectifiers with hot swappable function; the rectifier normal operation range is 90-290VAC
- RPD2151-48S48, DC -48v power supply card

## Standalone EPON OLT

### ISCOM6810

ISCOM6810 is one model of 1U 10G PON ISCOM6810 series products, which is compatible 1G EPON and 10G EPON symmetric/asymmetric modes. The model is in support of full-line speed forwarding and max. access 2048 ONUs with ratio of 1:256. It is facilitated in POL (Passive Optical LAN) networking for enterprise, hospital, campus, hotels and industry parks.

## FEATURES

- 8 x 10GE SFP+ optical interface uplink, 2 x GE electrical interface uplink; 8 x 10GEAPON interface (symmetric/asymmetric)
- Max. ratio of 1:256 and 2048 ONUs access for full loading
- Support IEEE 802.3av (10G EPON) standard
- Support line protection for main line and remote disaster recovery (TYPE B one-way/two-way)
- Support RSTP/MSTP, G.8032 Ethernet ring protection protocol and G.8031 linear protection, switching time meets telecommunication requirement for 50ms
- Support basic function of VLAN, QinQ, QoS, ACL
- Support routing protocols of IPV4/IPv6, RIP, OSPF, ISIS, BGP
- Support CLI, Telnet, SNMP (MSP platform) management
- Single outlet design, dual-power redundant for hot-swapping modular fan design facilitate removing fault



ISCOM6810



## Outdoor GPON OLT

### ISCOM5508Q-GP88-AC

ISCOM5508Q series are outdoor GPON OLT with cast aluminum casing and integrated EDFA targeted for outdoor applications. It supports 1550nm CATV signals with EDFA amplifier and multiplexing with up to 8 x GPON ports. The cast aluminum chassis provides support on wide range of operating temperature, lightning protection. The module is also equipped with Bluetooth connection as a convenient way for the console maintenance without connecting a serial cable. It supports a 1:128 split ratio, and thus is very suitable for low deployment in population density areas.



ISCOM5508Q-GP88-AC

## FEATURES

- Support 2 x 10G uplinks
- 4 or 8 GPON OLT ports with 1:64 split ratio
- Built-in EDFA for CATV distribution
- Redundant CATV optical input
- Support complete ACL, including L2, L3, L4, customized ACLs
- Support multicast, IGMP snooping, IGMP proxy, IGMP MVR
- Complete QoS support including DBA, priority control, traffic classification and queue scheduling
- Embedded dual power supplies
- IP67 protection to meet dust-proof and water-proof requirements
- Support working temperature from -20°C to 55°C

## GPON SFU ONT

### ISCOM HT803G-1GE

The GPON SFU type optical network terminal (ONT) series provides a flexible mix of residential access services including high speed data and IPTV services compliant with the ITU-T G.984 standard. In particular, the ONUs are designed for Ethernet data services, IPTV and wireless router accessing for various application scenarios, such as residential triple-play service and business connections. All GPON FTTH ONUs offer advanced end-to-end management and monitoring functionality, and the GPON series can be managed under the Raisecom NView platform.



ISCOM HT803G-1GE

P/N	ISCOM HT803G-1GE
WAN Interface	1 x GPON port, up to 20km transmission distance with a 2.5G downstream and 1.25G upstream rates
LAN Interface	1 x GE interface
VLAN, QinQ	Support VLAN, QinQ, QoS, DBA
Dimension(mm)	108(L) × 88(W) × 31(H)
Consumption	< 3W
Management	CLI, SNMP and OMCI via OLT

## GPON HGU ONT

### ISCOM HT803G-WS2

The GPON HGU type optical network terminal (ONT) series provides a flexible mix of residential access services including high speed data service, IPTV, voice services compliant with the ITU-T G.984 standard. In particular, the ONTs are designed for Ethernet data services, voice over IP, IPTV, wireless router accessing and convenient USB2.0 home network storage connections for various application scenarios, such as residential triple-play service and business connections. The GPON ONT series offer flexible choices in terms of downlink types and numbers, such as, GE/FE auto-adapting Ethernet ports, POTS (FXS) interfaces, RF port and WiFi function compliant with IEEE 802.11b/g/n/ac. All GPON FTX ONUs offer advanced end-to-end management and monitoring functionality, and the GPON series can be managed under the Raisecom NView platform. With data rates more than 866Mbps, user experiences are smoother and supports more devices.



ISCOM HT803G-WS2

P/N	ISCOM HT803G-WS2
WAN Interface	1 x GPON port, up to 20km transmission distance with a 2.5G downstream and 1.25G upstream rates
LAN Interface	4 x GE
POTS	2 x FXS
USB	1 x USB2.0
WLAN	802.11 b/g/n/ac, 2.4GHz & 5GHz, up to 4 SSIDs, MIMO 2 x 2, external Antenna
Dimension(mm)	184(L) x 129(W) x 38(H)
Consumption	<18W
TCP/IP	Support PPPoE Client, DHCP Server/Client, NAT, Static Route, ALG and Wifi Bridge
Management	Web management, Telnet, CLI and OMCI, TR-069

## SOHO/Enterprise Gateway

### MSG1200 Series, MSG2100 Series, MSG2200 Series, MSG2100E Series, MSG2600E Series

Raisecom PON/Ethernet gateway family consists of data-access gateway like MSG2100 series and MSG2200 series and converged gateway like MSG1200 series, MSG2100E series and MSG2600E series. MSG1200-UPON/MSG2200/MSG2100E/MSG2600E series products are the third-generation gateway launched by Raisecom, which meet the needs of SMEs, schools, industry branches, micro enterprises and street shops for bandwidth acceleration and performance improvement, and have SD-WAN access and VPN tunnel capabilities. The products adopt dual-core/quad-core CPU technology, integrating data, voice, security, wireless and other functions to provide users with integrated network access solutions of gigabit broadband and smart government & enterprises.

The MSG1200-UPON/MSG2200/MSG2100E/MSG2600E series products have cloud platform access capabilities, establish a VxLAN tunnel as the cloud access terminal for SDN controller and vCPEs. The 10G EPON port for MSG2600E series products is compatible with both symmetric and asymmetric rate modes.

The MSG2100-UPON-AC product is the gateway specially launched by Raisecom for video monitoring services such as safe city and bright project (Public Security Prevention and Control Project). It is designed with metal shell for high level of safety protection/lightning protection, and small size for easy to be installed in the outdoor transfer box. It is in support of local WEB and TR069 platforms to issue configuration, simplify the configuration process, and facilitate later management and maintenance.

Raisecom gateways have secure access capabilities, support access control, IPsec VPN, L2TP VPN, GRE VPN, and provide security guarantees for the services access of enterprise users.

Users can flexibly deploy multiple services on the same platform to reduce the network operation and maintenance costs.



MSG1200-UPON



MSG2100E-UPON-4V



MSG2100E-UPON-16V-AC

## FEATURES

### Performance and reliability

- High performance and low power consumption, dual-core/quad-core CPU, 900MHz/1.2GHz
- Small size and good durability
- No fan, no noise, and high reliability

### Interface type

- Provide EPON/GPON self-adaptive uplink mode, and optional USB external 4G uplink link backup in WAN side
- Provide GE ports in LAN side, and one of them can be configured as the uplink port

### Routing access

- Support IPv4/IPv6 dual stack, DS-lite tunnel
- Support routing, bridging, NAT, port mapping, DHCP, UPNP and other functions to meet users' basic access requirements
- Support VLAN management and MAC management to facilitate equipment service and port planning
- Support static routing and policy routing protocols
- Support routing backup
- Support multicast IGMP Snooping and IGMP Proxy
- Support rich and flexible QoS scheduling mechanisms: PQ, WRR, etc.

### VPN function

- Support multiple VPNs such as IPSec, L2TP, and GRE
- Support VxLAN, which can uplink to SDN controller and vCPE

### Security function

- Support firewall and access control policies
- Support DDoS, anti-ARP attack, and port scanning defense
- Support MAC, IP and URL filtering
- Support various user authentication modes, such as Radius/LDAP/IP/MAC, support web page push, and various Portal protocols

### Voice function (except MSG2100-UPON-AC, MSG2200 series)

- Support SIP, H.248 and IMS-SIP voice protocols at the same time
- Support G.711a/u, G.723, G.726, G.729 voice codec auto-negotiation
- In terms of voice service, the PSTN supplementary services such as holding, waiting, forwarding calls, three-way calling, hotline service, and Centrex can be implemented to form a rich and powerful overall IP voice solution, providing customers with more voice service experiences

### Management function

- Support multiple management modes, such as TR-069, Web, and SNMP to facilitate service provisioning and operation & maintenance management
- Support zero-configuration for plug and play
- Support NAT-traversal to solve the problem of network management connection between public network and private network



MSG2200-T4



MSG2200-UP



MSG2200-UP-8E



MSG2600E-XES-8E8V-WS3

Software Features		
L2/3 function	Access function	Support routing, bridging, NAT, port mapping, DHCP, UPNP and other functions to meet users' basic access requirements Support IEEE 802.11, MAC management, and VLAN management Support 4G uplink link backup
	Multicast function	Support multicast IGMP Snooping, and IGMP Proxy
	Speed limit function	Support port speed limit, and QoS speed limit
	Routing	Support static routing, policy routing, and route backup
Voice function (except MSG2100/MSG2200 series)		Support SIP, H.248 and IMS-SIP voice protocols Support G.711a/u, G.723, G.726, G.729 voice codec Support T.30/T.38 fax, three-way calling, DND, and call accounting functions
IPv4/IPv6		Support IPv4/IPv6 dual stack, Routing & data forwarding, DS-lite tunnel
Advanced features	VPN	Support IPSec VPN, L2TP VPN, GRE VPN, VxLAN VPN, and PKI management
	QoS	Support priority mapping, traffic monitoring (CAR), traffic shaping, congestion management, and priority management
	Security	Support basic firewall, website filtering, MAC address filtering, and access control Anti ARP and DDoS attacks Support Web authentication, RADIUS authentication, and illegal IP detection

## MSG2100/MSG2200 Series Data-Access Gateway

P/N	MSG2100-UPON-AC	MSG2200-UP	MSG2200-UP-8E
WAN	1 x EPON/GPON self-adaptive interface		
4G interface	N/A	optional USB external 4G NIC	
LAN	4GE	4GE, dualfrequency WiFi port	8GE, dualfrequency WiFi port
USB interface	N/A	USB2.0/3.0 high-speed interface	
WLAN	N/A	IEEE 802.1b/g/n/ac (4 x 4 MIMO), 4 external 5dBi antennas	
Weight	0.4Kg	1.2Kg	1.3Kg
Dimension(mm)	135(L) x 105(W) x 28(H) (metal shell)	260(L) x 130(W) x 43(H) (metal shell)	
Power Supply	+12V power adapter		
Max power consumption	≤6W	≤21W	≤22W
Operating environment	Operating humidity: 10% ~ 90%, non-condensing Operating temperature: -5°C ~ 55°C; (except MSG2100-UPON-AC; -20 ~ 65°C for MSG2100-UPON-AC)		
Storage environment	Environment temperature: -25 ~ 70°C; Environment humidity: 10% ~ 90%, non-condensing		
Dust level	IP20		

## MSG1200/MSG2100E/MSG2600E Series Converged Gateway

P/N	MSG1200-UPON	MSG2100E-UPON-4V	MSG2100E-UPON-16VAC	MSG2200-T4
WAN	1 x EPON/GPON self-adaptive interface			
4G interface	optional USB external 4G NIC			
LAN	4GE, single-frequency WiFi port			8GE
Voice interface	2 x FXS voice interfaces, RJ-11	4 x FXS voice interfaces	16 x FXS voice interfaces	8 x FXS voice interfaces
USB interface	USB2.0/3.0 high-speed interface			
WLAN	IEEE 802.1b/g/n (2 x 2 MIMO), singlefrequency 2.4G Hz, builtin antennas, interface QTY.: ≤30	IEEE 802.1b/g/n (2 x 2 MIMO), single-frequency 2.4G Hz, 2 external 5dBi antennas		
Weight	0.3Kg	0.9Kg	2.1Kg	1.7Kg
Dimension(mm)	185(L) x 130(W) x 39(H) (plastic shell)	260(L) x 130(W) x 43(H) (metal shell)	440(L) x 220(W) x 43(H) (metal shell)	320(L) x 200(W) x 43(H) (metal shell)
Power Supply	+12V power adapter		AC 220V power supply	
Max power consumption	≤10W	≤12W	≤27W	≤22W
Operating environment	Operating temperature: -5°C ~ 55°C; Operating humidity: 10% ~ 90%, non-condensing			
Storage environment	Environment temperature: -25°C ~ 70°C; Environment humidity: 10% ~ 90%, non-condensing			
Dust level	IP20			

## MSG2600E Series 10G EPON Converged Gateway

P/N	MSG2600E-XES-8E8V-WS3
WAN	1 x 10GEPON interface
LAN	8GE
Voice interface	8 x FXS voice interfaces, RJ-11
USB interface	USB2.0/3.0 high-speed interface, optional USB external 4G NIC
WLAN	IEEE 802.1b/g/n/ac (2x2 MIMO), dual-frequency 2.4G/5G Hz, 2 external 5dBi antennas, and suggest interface qty.: ≤30
Weight	1.5Kg
Dimension(mm)	320(L) x 200(W) x 43(H) (metal shell)
Power Supply	AC 220V power supply
Max power consumption	≤30W
Operating environment	Operating temperature: -5°C ~ 55°C; Operating humidity: 10% ~ 90%, non-condensing
Storage environment	Environment temperature: -25°C ~ 70°C; Environment humidity: 10% ~ 90%, non-condensing
Dust level	IP20

## GPON Stick ONT

### ISCOM HT801-GSFP

The ISCOM HT801-GSFP is a GPON ONT stick. It is in the SFP form and can be inserted into the SFP uplink interface on switches, IP cameras, Small Cells, routers, DSLAMs, or other devices to implement video backhaul or wireless backhaul. In this way, the networking is changed to use GPON with less complexity in communication and connectivity lower power consumption and cost, and improved network reliability.

## FEATURES

- SFP form, small size, elegant appearance, and light weight
- Compliance with ITU-T G.984/G.988
- Cost-effective and suitable for large-scale applications
- Fully compatible with OLTs of other vendors



ISCOM HT801-GSFP

## Standalone CATV EDFA

### RC5827A-4, RC5830A-8, RC5833A-16, RC5836A-32X-WS

Raisecom standalone CATV EDFA includes models of RC5827A-4, RC5830A-8, RC5833A-16 and RC5836A-32X-WS. All models are 19-inch stand-alone product, integrated by splitter, optical amplifier, and 1270 & 1310/1490 & 1571/1550nm wavelength multiplexer, supports 1 or 2 CATV input port, up to 32 PON input ports and 32 COM (CATV+PON) ports. It is optical switch integrated for models with 2 CATV input port. Output power for each EDFA output port is 19dBm. All models support dual AC/DC power supplies and redundant backup.

RC5830A-PWR-D is a pluggable power supply module for RC5827A-4, RC5830A-8, and RC5833A-16. The output power is -48V DC.

RC5830A-FAN is a pluggable Fan module for RC5827A-4, RC5830A-8, and RC5833A-16.

## FEATURES

- 1540nm~1565nm operating bandwidth for optical amplifier
- Low Noise Figure: Max.  $\leq 5.5$ dB, (@Pin=0dBm,  $\lambda=1550$ nm)
- High performance, high reliability
- Polarization dependent gain: Max. 0.4dBm
- Polarization mode dispersion: Max. 0.5ps
- Input and output pump leakage: -30dBm
- 1550nm output optical port, multiplex 1310nm/1490nm or 1270nm/1571nm data stream
- Be compatible with be compatible with any FTTx PON Technology: EPON/GEAPON, GPON, BPON, DPON and XGPON
- Perfect RS232, SNMP
- Efficient space, flexible installation and easy operation



RC5830A-8

## Splitter

### Passive Optical Splitter

The optical splitter is a passive optical plug-and-play device, which connects OLT and ONUs with multiple fiber ends. A splitter is generally deployed in an optical

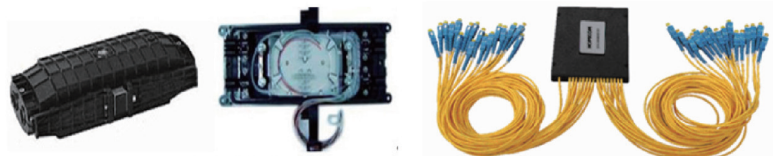

Outdoor Optical Splitter

Indoor/Outdoor Optical Splitter

distribution network, allowing carriers to split optical signals to numerous customer premises. Raisecom provides various optical splitters with the following split ratios: 1:2, 1:4, 1:8, 1:16, 1:32, 1:64 to 1:128. The series is classified as indoor, indoor/outdoor and outdoor optical splitters



# Chapter 5. Smart Home Routers

As the core of the smart home, the router can be connected to various smart terminals, such as TV, phone, pad, speaker, STB, Xbox, VR glasses, etc. These demands put many requirements on the router. For performance and multi-terminal access scenario, Raisecom DR series router uses high-quality CPU and Wi-Fi chips. For far different categories of family members, DR series router implements access control, such as parental control (teenage mode). For covering different types of houses, we use multiple antennas, even mesh networking, and G.hn Turbo power line technology to achieve full coverage. For the use of equipment, we have implemented a three-step fast configuration and also provided safety guarantees. The DR series of wireless network router launched by the Raisecom intelligent networking terminal product line aims to meet the needs of smart home, via access fiber to home, network full coverage in a house, combine intelligent control, information exchange and consumption services effectively, provide uses with complete, high performance, reliable, standard innovative broadband service experience.

## Residential Routers

### DR5254, DR5264 series

As the hub connecting Internet at home, wireless routers are widely used in daily life and become an indispensable network device at home. With the upgrade of optical fiber and the rapid development of communication technology, home broadband access demand is also upgraded, which brings higher performance requirements for home routers. The DR series router aims to use the wireless technology to change the home network, so that every family can enjoy unlimited high-bandwidth networks.

DR5254 & DR5264 are the main models of the intelligent networking terminal, which uplink to the gateway through a network cable and then downlink with high-speed network extension service through wired and wireless methods. It adopts the high-powered CPU to ensure system operating fast and stable. It has 1 GE WAN port, 2 GE LAN ports, and 4 omni-directional antennas. DR5264 supports Wi-Fi 6 which is a new generation of IEEE802.11a/n/ac/ax,5GHz and IEEE802.11b/g/n,2.4GHz wireless technology, and provides wider coverage and more efficient transmission. The total dual-band concurrent bandwidth is up to 1800Mbps, which enables users surf internet faster and smoother.



## FEATURES

### Elegant Appearance

- Be suitable for desktop layout; support built-in antennas on DR5254 and external antennas on DR5264 appearances

### High-speed full-gigabit networks

- Upgrade the bandwidth just in one step; adopt full-Gigabit network port design, 1 Gigabit WAN port, and 2 Gigabit LAN ports.
- Max. 1167Mbps for Wi-Fi 5 router and Max. 1775Mbps for Wi-Fi 6 router

### High-performance antenna

- 4 high-performance antennas to achieve the omni-directional family coverage
- 2.4GHz with strong wall penetration and wide coverage, while 5GHz with low latency and high rate

### WAN/LAN auto-adaption

- With the support of the network port automatic identify technology, you can plug in the 3 Gigabit ethernet ports as you like, and there will be auto-recognized uplink/downlink port no error

### IPv6

- All-round upgrade to support IPv6 (compatible with IPv4), more addresses, more secure

### Band-steering

- Combined 2.4GHz and 5GHz to one SSID, intelligent automatically connects users' devices to faster frequency

### Easy Setup

- Easy setup in 3 steps with Smart Phone, easy to use

P/N	DR5254	DR5264
WAN Interface	1 x Gigabit WAN port	
LAN Interface	2 x Gigabit LAN ports	
CPU	Dual-core 900MHz	
RAM	128 MB	256 MB
Flash	128 MB	
WLAN	802.11 b/g/n/ac, AC1200, 2.4 GHz & 5 GHz, 2 x 2 MU-MIMO, 8 SSIDs, 4 x built-in 3dBi Antennas	802.11 b/g/n/ac/ax, AX1800, 2.4 GHz & 5 GHz, 2 x 2 MU-MIMO, 8 SSIDs, 4 x external 5dBi Antennas
Dimension(mm)	105(L) x 105(W) x 68(H)	220(L) x 130(W) x 36(H)
Power Supply	12V DC, 1A	12V DC, 1.5A
Software	Support PPPoE, DHCP Server/Client, static IP, WPS, IPv4/IPv6, DNS client/relay, NAT, Firewall, parent control, Accept/Reject list, DMZ, IGMP snooping/proxy	
Management	Web management, APP, OTA	

## G.hn Routers

### DR8354 series

Adopting global leading power line technology G.hn Turbo, Raisingcom G.hn routers replace the network cable by electric wire, just plug-in and enable users to surf Internet with high performance. In addition, it can be placed anywhere according to the needs without wall-through design. Through the G.hn Mesh distributed networking technology, it is easy for users in different rooms to roam seamlessly for a better experience with Wi-Fi coverage.

In buildings with thick concrete walls or steel infrastructures, Raisingcom's G.hn is preferred product for the home network. In these scenarios, Raisingcom G.hn is much easier to deploy optimally in the home network and saves up to 70% less radio transmitting power required for similar coverage using Wi-Fi. This ensures a greener and healthier environment for the family. Up to 8 routers can be distributed in one network, to covering home size over 1000 sqm. Networking efficiency is 30% higher than traditional Wi-Fi Mesh network. Subscribers can also set unperturbed mode through App setting according to their own preferences, to enjoy a new home-style router networking experience.

## FEATURES

### Brief Design

- Eiffel Tower-like design, with elegant outlook and industry-leading exquisite technique, offering new home router experience, and refreshing mode for home Internet access

### High-speed full-gigabit networks

- 1 Gbps powerline communication standard, supporting G.hn Turbo
- Full-Gigabit interfaces port design, WAN/LAN auto-adaptive
- Support Wi-Fi 5 AC1200 for wireless connection, and maximum rate can reach 1167Mbps

### Plug and Play

- The power line cable is used here to also transmit data. Once the device is powered on, it can access the Internet
- Once the Satellite signal is put in, it will synchronize the Wi-Fi name and password from the Base, don't need any configuration

### Super Coverage & Seamless Roaming

- G.hn Mesh supports 8 routers to network at the same time.
- The signal coverage can reach 1000 square meters, and the network efficiency is 30% higher than that of traditional Wi-Fi mesh

### Night mode

- Allowing you to shut down LEDs, thus offering you better sleep environment without light interference

### Band-steering

- Combined 2.4GHz and 5GHz to one SSID, intelligent automatically connects the users' devices to faster frequency

### Easy configurations

- Only 3 steps for configuring the base router, without any configurations for the satellite router in the package, which can support adaptive networking based on G.hn Mesh



P/N	DR8354
WAN Interface	1 x Gigabit WAN port
LAN Interface	2 x Gigabit LAN ports
CPU	Dual-core 900MHz
RAM	128 MB
Flash	128 MB
Powerline Standard	1Gbps G.hn Turbo
WLAN	802.11 b/g/n/ac, AC1200, 2.4 GHz & 5 GHz, 2 x 2 MU-MIMO, 8 SSIDs, 4 x built-in 3dBi Antennas
Dimension(mm)	123(L) × 69.7(W) × 182.5(H)
Power Supply	100-240 VAC 50/60 Hz 0.1 A
Software	Support PPPoE, DHCP Server/Client, static IP, WPS, IPv4/IPv6, DNS client/relay, NAT, Firewall, parent control, Accept/Reject list*, DMZ*, IGMP snooping/proxy
Mesh	G.hn Mesh (Up to 8 routers) Seamless Roaming
Management	Web management, APP, OTA

# Chapter 6. WLAN

AC+AP structure is the solution to help enterprise/campus network improve Wi-Fi coverage, performance and maintenance. Raisecom AC+AP solution provides varied products and is suitable for all enterprise network scenarios, such as POL which sets a cost-saving passive optical network for enterprises, and is also widely used in campus network, business building, public area, plaza, hotels, and stadium etc. Raisecom provides comprehensive AC and AP functions, such as privilege management, cloud and local deployment, AP monitoring & trouble-shooting, AP remote configuration and management, HAP, scheduled upgrading, and provides high wifi performance by advanced wifi AP, such as 802.11AC wave 2.

Besides, Raisecom intelligent AC with data analysis feature helps enterprise to analyze their customer/visitor information, such as real-time customer/visitor flow, customer/visitor flow trend (arriving time, visit times, stay time) that will be quite helpful in service adjustment.

Raisecom wireless solution also support all popular authentication methods which would be very convenient for end-users to access quickly, such as the 3rd party famous APP integrated authentication, SMS authentication, and other unaware authentication etc.

## AC Device

### MSG2300-iWNC

Raisecom MSG2300-iWNC is a software product which is cloud based and can support up to decades of thousands of APs with millions terminal devices. It is designed for huge wireless network, supports all traditional AC features, and also has enhanced functions, such as cloud deployment, wireless cloud management, wireless network status monitoring, user authentication, user management etc., it has the best resilience and stability by distributed deployment and modular design, simplifies huge wireless network construction and can be widely applied to big enterprise wireless network.

## FEATURES

- For huge wireless network management by cloud
  - Cloud centralized management architecture
  - Flexible deployment for both centralized and distributed management architecture
- Distributed MCP deployment with high stability
  - Modular MCP design makes it easy to expand and stable with BU/AP increased
- Visual wireless network management based on MAPs
  - Hotspot management based on location
  - Hotspot distribution monitoring
  - Hotspot information display
- Visual network monitoring and alarm
  - AP and terminal real-time monitoring
  - Alarm display based on maps
  - Support alarm by SMS and email
- support multi-users multi-level operation and maintenance
  - This is quite suitable for wifi provider operation
  - Cloud platform can virtualize many vAC which can isolated between each other with its own account
  - And there is also a super administrator to manage all ACs and APs
- Support interwork with wireless sales platform
- Integrated with rich APIs makes it easy to interwork with wifi operation platform
- Rich and convenient AP configuration and management functions

## Hardware specification

P/N	MSG2300-iWNC BU	
Environment requirement	Minimum CPU, Intel Xeon E3 4cores*8threads, frequency 2.5Ghz. Minimum RAM, 8GB. Minimum Disk, 200GB. Minimum Network interface, 1000Mbps. Operate system, Ubuntu Linux 14.04 *64bits.	
AP capacity	up to 2000	
P/N	MSG2300-iWNC BU	
Environment requirement	Minimum CPU, Intel Xeon E5 8cores*16threads, Frequency 2.5Ghz. Minimum RAM, 8GB. Minimum Disk, 1000GB. Minimum Network interface, 1000Mbps. Minimum physical Server, 1. Operate system, Ubuntu Linux 14.04 *64bits.	Minimum CPU, Intel Xeon E5 8cores*16threads, Frequency 2.5Ghz. Minimum RAM, 16GB. Minimum Disk, 2000GB. Minimum Network interface, 1000Mbps. Minimum physical Server, 3. Operate system, Ubuntu Linux 14.04 *64bits.
AP capacity	AP number <10000	AP number 10000~50000
BU number	1~5 units	5~25 units

## Software specification

P/N	MSG2300-iWNC
Performance	simultaneous AP online capacity, 50000. simultaneous Terminals online capacity, 1000,000. BU simultaneous manage capacity, 25
WIFI operation	Proxy User management, account management, username, password, expire time; Proxy User binding AC setting. Proxy user devices management, proxy user binding AP setting by themselves and administrator,
Reliability	Wi-Fi reliability, HAP- AP keep working after AC offline Platform reliability, distributed AC deployment, AC can always work when some AC fail
CAPWAP	Support L2/L3 network between AP and AC Auto discovery of AC AP support NAT traversal AP auto upgrade by AC AP auto load configuration by AC
Data transmit	Distributed data transmit
Portal authentication	Portal1.0, Portal2.0 Radius User unaware authentication Terminal black list Support dedicate terminals online without authentication URL/IP whitelist
Wireless protocols	802.11, 802.11b, 802.11a, 802.11g, 802.11d, 802.11h, 802.11w, 802.11k, 802.11v, 802.11r, 802.11i, 802.11e, 802.11n, 802.11ac, 802.11ac wave2
Wireless QOS	Bandwidth control by AP/SSID, static and intelligent bandwidth control by user
User isolation	Based on AP and BSS
User management	Control by AP user number/SSID user number/AP user number load balance/AP traffic load balance
RF management	Country code/TX power setting in 1db/auto setting tx power/auto setting working channel/auto negotiate transmit rate/black hole compensation/rf interference detection and avoid
Security	Multiple SSID, SSID hidden encryption methods, PSK, WPA/WPA2, WEP/WEP128, WAPI, TKIP, CCMP Arp spoofing Rogue AP detection and prevention
Configuration management	Wi-Fi start by schedule AP name, place, maximum user access; Bandwidth control by BSS; Locate terminals position by Wi-Fi – location server IP, port, heart beat interval; ARP and DHCP broadcast transfer to unicast; AP templates AP remote management AP upgrade
Monitoring	AP monitoring, AP status, AP setting, query AP status by MAC, IP; STA monitoring, query status by STA by AP MAC, STA MAC, IP; STA force offline; STA logging; AP logging;

## Intelligent and high performance standalone AC

### MSG2300-WNC512-PT, MSG2300-WNC1204-PT

MSG2300-WNC1024/512-PT is a pizza box -1U high wireless access control device. The maximum number of manageable AP is up to 1024, and it integrates with AAA and data analysis feature. One device for sales system and analysis system, supports SMS, WeChat, register account, LDAP, user unaware authentication, and supports customer flow analysis, including real-time customer flow, flow trend, new and existed customer, Arrive time, Stay time, Visit time, terminal device vendors analysis etc.

## FEATURES

- High-performance and high-availability wireless network
  - Raisecom HAP – Wi-Fi can work contiguously while AC is offline
  - 1+1 standby feature, providing high availability
  - Support IEEE 802.11 a/b/g/n/ac/ac wave2 Aps management
  - Optimize distributed forwarding and centralized management
  - Recognize and prevent rouge AP
- Safe and friendly wireless customer analysis feature
  - Support more than 10 certification methods.
  - Easy to customize certification web page based on self service
- Multi-dimensional customer flow analysis
  - Big detail page for big screen
  - Real-time customer flow
  - Customer flow analysis data
  - Terminal vendors analysis
- Efficient and convenient wireless network management
  - Multi-user and multi-level maintenance
  - AP plug and play
  - Network management based on maps
  - Visual network management and monitoring
  - Intelligent RF management



MSG2300-WNC512-PT



MSG2300-WNC1024-PT

## Physical specification

P/N	MSG2300-WNC512-PT	MSG2300-WNC1024-PT
LAN Interface	6 x 10/100/1000Mbps copper interface	2 x 10/100/1000Mbps copper interface
Management interface	2 x USB2.0 interfaces, 1x console serial interface	4 USB3.0 interfaces
Power adapter	100~240V AC, 50~60Hz	
Environment	Operate temperature 0~50°C humidity 10~90%RH storage temperature -40~70°C storage humidity 5~95%	
Consumption	<150W	<180W
Dimension(mm)	430(L) x 280(W) x 44(H)	
EMS	GB9254-2008	



## Software specification

P/N	MSG2300-WNC512-PT	MSG2300-WNC1024-PT
Capacity	AP Maximum <512 AP Maximum configuration number <2048 Wireless terminals associate number 15000 Portal maximum user online number 2000 Local certificated account number 70000	AP Maximum <1024 AP Maximum configuration number <4096 Wireless terminals associate number 30000 Portal maximum user online number 4000 Local certificated account number 70000
MAC table size	16k	32k
Wi-Fi Roaming switch time	50ms	
VLAN	4096	
ACL number	64k	
Wireless protocols	802.11, 802.11b, 802.11a, 802.11g, 802.11d, 802.11h, 802.11w, 802.11k, 802.11v, 802.11r, 802.11i, 802.11e, 802.11n, 802.11ac, 802.11ac wave2	
Wireless QOS	Bandwidth control by AP/SSID, static and intelligent bandwidth control by user	
User isolation	Based on AP and BSS	
User management	Control by AP user number/SSID user number/AP user number load balance/AP traffic load balance	
RF management	Country code/TX power setting in 1db/auto setting tx power/auto setting working channel/auto negotiate transmit rate/black hole compensation/rf interference detection and avoid	
CAPWAP	Support L2/L3 network between AP and AC Auto discovery of AC AP support NAT traversal AP auto upgrade by AC AP auto load configuration by AC	
Data transmit	Distributed data transmit	
HA	Wi-Fi HA, HAP- AP keep working after AC offline AC 1+1 standby	
Portal authentication	Portal1.0, Portal2.0 Radius interwork with the 3rd party AC	
Certification methods	Mobile phone message authentication The 3rd party famous platform account authentication - WeChat LDAP QR code One click authentication With APP authentication User unaware authentication	
Authentication free terminal setting	Set some terminals access without Authentication	
URL/IP white list	Any URL/IP can be set for all users access without authentication	
Customer flow analysis	Real-time customer flow Customer flow trend Big screen page New and existed customer analysis Arrive time analysis Stay time Visit time Terminal device vendors analysis Customer information analysis	
Security	Multiple SSID, SSID hidden encryption methods, PSK, WPA/WPA2, WEP/WEP128, WAPI, TKIP, CCMP Arp spoofing Rogue AP detection and prevent	
Configuration management	Wi-Fi start by schedule AP name, place, maximum user access; Bandwidth control by BSS; Locate terminals position by Wi-Fi- location server IP, port, heart beat interval; ARP and DHCP broadcast transfer to unicast; AP templates AP remote management AP upgrade	
Monitoring	AP monitoring, AP status, AP setting, query AP status by MAC, IP; STA monitoring, query status by STA by AP MAC, STA MAC, IP; STA force offline; STA logging; AP logging;	

## Comprehensive gateway integrated AC

### MSG2300-WNC256-GW

MSG2300-WNC256-GW developed for enterprise wireless network, integrated with enterprise level gateway, professional wireless controller, portal authentication system which provide intelligent wireless control, routing, firewall, VPN, flow control, portal authentication, etc. Raicom '-GW' type AC, one device for whole wireless network solution, make a lower cost for enterprises, and simplifies network maintenance, agile trouble-shooting, make deployment easier by ZTP.



MSG2300-WNC256-GW

## FEATURES

- Professional and safe and convenient wireless management
  - Provide management 802.11 a/b/g/n/ac AP
- Integrated with all wifi protocols 802.11 a/b/g/n/ac
  - HAP work mode - AP can keep working when AC fails
  - Plug and work - AC auto discovery by AP, agile enable wireless network by ZTP, work with existed switches, firewalls, AAA server and other systems without any changes. AP can be plug and play with Gateway-AC, auto configuration all APs by center AC, include all configuration, upgrade, security strategy, etc Monitor all network performance data
- Virtualized
  - RF management
  - Wireless user management and trouble-shooting
  - Support AP auto-upgrading
  - Carrier-grade wireless user access management
  - Rouge AP detection and prevention
  - Intelligent AP load balance
- Rich authentication methods
  - Intelligent portal.
  - User unaware authentication
  - Wired and wireless authentication in the same system
  - Authenticate by the 3rd party APPs
  - Mobile phone SMS authentication
  - Interwork with the 3rd party AAA server
- Stable, reliable enterprise gateway features
  - Firewall, VPN
  - Multiple WAN access, load balance
  - Smart flow control

## Physical specification

P/N	MSG2300-WNC256-GW
LAN Interface	4 x 10/100/1000Mbps copper interface
Management interface	2 x USB2.0 interfaces, 1x console serial interface
Power adapter	100~240V AC, 50~60Hz
Environment	Operate temperature 0~50°C humidity 10~90%RH storage temperature -40~70°C storage humidity 5~95%

## Software specification

P/N	MSG2300-WNC256-GW
Capacity	AP Maximum <256 Wireless terminals associate number 12000 Portal maximum user online number 200
Wireless protocols	802.11, 802.11a, 802.11b, 802.11g, 802.11n, 802.11d, 802.11h, 802.11i, 802.11e, 802.11k
Wireless QOS	Bandwidth control by AP/SSID, static and intelligent bandwidth control by user
User isolation	Based on AP and BSS
User management	Control by AP user number/SSID user number/AP user number load balance/AP traffic load balance
RF management	Country code/TX power setting in 1db/auto setting tx power/auto setting working channel/auto negotiate transmit rate/black hole compensation/rf interference detection and avoid
CAPWAP	Support L2/L3 network between AP and AC Auto discovery of AC AP support NAT traversal AP auto upgrade by AC AP auto load configuration by AC
Data transmit	Distributed data transmit
Portal authentication	Portal1.0, Portal2.0 Radius interwork with the 3rd party AC
Certification methods	Local authentication Mobile phone message authentication 3rd party famous platform account authentication - WeChat One click authentication User unaware authentication
Authentication free terminal setting	Set some terminals access without Authentication
URL/IP white list	Any URL/IP can be set for all users access without authentication
Security	Multiple SSID, SSID hidden encryption methods, PSK, WPA/WPA2, WEP/WEP128, WAPI, TKIP, CCMP
	Arp spoofing
	Rogue AP detection and prevent
Configuration management	Wi-Fi start by schedule AP name, place, maximum user access; Bandwidth control by BSS; Locate terminals position by Wi-Fi – location server IP, port, heart beat interval; ARP and DHCP broadcast transfer to unicast; AP templates AP remote management AP upgrade
Monitoring	AP monitoring, AP status, AP setting, query AP status by MAC,IP; STA monitoring, query status by STA by AP MAC, STA MAC, IP; STA force offline; STA logging; AP logging;
NAT	1:1 IP translation
	N:N IP translation
	PAT
Basic functions	DHCP, option43 for AC IP
	DNS proxy
Firewall	ACL rule, based on IP, tcp/udp port
Rate limit	Terminals rate limit by IP
VPN	IPSEC, L2TP

## Wireless APs

### MSG230 series

Raisecom MSG230 series wireless products are the new generation 802.11ac wave2 access point device which supports up to triple-band and up to 3Gbps bandwidth, MU-MIMO & wider RF bandwidth-160MHz channels & up to 256-QAM modulation, makes huge access device number and higher bandwidth with better performance. MSG230 series have many different types, including indoor, outdoor, wall-mounted, ceiling, socket type fixing into wall, which can be applied to many different scenarios, such as business building, campus, hotel, school, hospital, shopping mall, convention center, stadium, airport, railway station, public service center, and scenic spot, etc.



MSG230-G2T-C2T-XD14



MSG230-C2D-XD12



MSG230-G2D-RQ12



MSG230-C2D-SWD2



MSG230-C2D-SWO2

## FEATURES

- Advanced wifi technology with triple-band access  
The innovative triple band technology offers customers 5.1GHz+5.8GHz+2.4GHz high density and extremely high performance access. The total Wi-Fi rate is up to 3Gbps. The triple band access solution is suitable for a high density scene such as conference plaza, stadium and big classroom
- Agile deployment with ZTP makes it plug and play
- Multiple users' simultaneous communication increase access capacity apparently Raisecom new generation AP supports Multi-user MIMO (MU-MIMO) technology, MU-MIMO allows the AP to transmit data to multiple terminal devices simultaneously which improves data transmission efficiency, raises the number of users accessing the AP and provides better user experience
- Intelligent AP load balancing  
AP load balancing can make traffic loaded in different APs in balance. It will access in a best light traffic loading AP while a new terminal comes to up while the first access AP is over the traffic/access-number threshold

## Physical specification

P/N	MSG230-C2T-XD14	MSG230-C2D-XD12	MSG230-C2D-RQ12	MSG230-C2D-SWD2	MSG230-C2D-SWO2
Type	Indoor			Outdoor	
Physical Installation	Wall mounted/Ceiling		Fixing Wall in type socket	Wall mounted/ Ceiling	
Antenna	Omnidirectional			Orientation	Omnidirectional
2.4G/5G gain	4dBi/5dBi	2dBi/ 3dBi	3dBi/3dBi	10dBi/ 12dBi	4dBi/5dBi
Wi-Fi protocols	802.11a/b/g/n/ac wave2				
Simultaneous RF working	Triple-band (2.4Ghz+5.1Ghz+5.8Ghz) (2.4Ghz+5.1Ghz+5.8Ghz)	Dual-band(2.4Ghz+5Ghz)			
Streams - SU/MU-MIMO	2 x 2 + 2 x 2 + 4 x 4		2 x 2 + 2 x 2		
Dimension(mm)	210(L) x 210(W) x 50(H)	190(L) x 190(W) x 43(H)	115(L) x 86(W) x 44(H)	240(L) x 240(W) x 90(H)	224 (Diameter) 245(height)
Interface	1WAN, 2LAN	1WAN,1LAN	1WAN,4LAN 2*RJ11 (voice)	1WAN,1LAN	
Consumption	<25W	<15W	<11.5W	<25W	
Power adapter	DC: 12V/2.5A or PoE	DC: 12V/1.5A or PoE	DC: 48V/0.38A Or POE	PoE	
PoE(PSE)	802.3at				
Operate temperature	-10°C~55°C	-10°C~50°C	-0°C~40°C	-40°C~65°C	
storage temperature	-40°C~70°C			-40°C~85°C	
Industrial protection level	IP53	IP41		IP67	
Environment humidity	Operating humidity 5~95%RH				

## Software specification

P/N	MSG230 Series	
Type	Indoor Models: MSG230-C2T-XDI4 MSG230-C2D-XDI2 MSG230-C2D-RQI2	Outdoor Models: MSG230-C2D-SWD2 MSG230-C2D-SWO2
WLAN	DCA/TPC/SSID hidden Country code RF enable/disable SSID enable/disable by schedule RTS/CTS RF scan Link integrity check Limit user number Weak signal terminals access limit Force Roaming based on signal level	
Wi-Fi location	Scan internal setting Scan type setting(location label/common terminals) Monitor mode Work mode Location report Ignore dedicate terminals	
11n,11ac enhanced	40MHZ binding/80MHZ binding/160MHZ binding MU-MIMO A-MPDU/MLD Tx beamforming MRC/STBC/LDPC	
Security	64/128WEP, TKIP, CCMP Encryption WPA-PSK, WPA2-PSK,WPA, WPA2 WAPI Portal authentication WIDS/WIPS MAC filter Real-time RF protection Anti-dos Forward security by frames filter/whitelist/blacklist User isolation Anti TCP/UDP/ICMP/ARP flooding Management and service data isolation ACL rule Wireless terminals access control	
Network functions	WAN static/dhcp/pppoe setting VLAN Spanning-tree Routing protocol AC auto discovery Data Local forwarding Data centralized forwarding Capwap, and backup Link integrity check CAPWAP link check IgmP snooping Roaming AP switching based on signal level, code error radio, RSSI, S/N, neighbor AP states	
QoS	WMM Priority mapping QoS policy L2-L4 packets filter and classification Load balance User number limit Bandwidth control Low power mode HAP Intelligent terminal detection BYOD Value-added wireless service Optimize service by translating Multicast to unicast	
Management features	Centralized management with FAT/FIT mode SHH, telnet, web Configuration by http/https/CLI SNMP Logging/syslog Alarm Faults detection Statistics Neighbor AP scan NTP/FAT/FIT setting AP online upgrade Remote probe analysis Dual system Watch dog	



# Chapter 7. Industrial Switch

As the Ethernet technologies mature, Industrial Ethernet products and solutions are gaining popularity in the vertical industrial, utility, transportation and public marketplaces for their core values of enhanced manageability, network redundancy, scalable bandwidth up to GE and 10G, and comprehensive performance monitoring. In addition, the managed Ethernet technologies, which are introduced into industrial applications assist with the integration of many systems over an expandable network across wired and wireless LANs and WANs.

Gazelle Series created by RAISECOM is mainly utilized for complicated application scenario in the industry fields, such as smart grid, traffic control and surveillance system. The selected models are specially adapted with advanced performance on QoS, network security, resiliency and reliability for a wide range of industrial applications. In addition, this series, complying with IEC 61580-3 and IEEE 1613, is capable of ensuring high standards of EMI immunity and error-free communication, which is significant function in power plants, substations, transmission lines and ammeter readings. Having reinforced hardware design supports effective and efficient protection mechanism within 50ms, thereby increasing network reliability and reducing the cabling and wiring complexity.

## L2 DIN-Rail Manageable Industrial Switch

**Gazelle S1000i-LI Series, Gazelle S1010i-GL Series/ Gazelle S1020i-GL Series, Gazelle 1020i-LI Series, Gazelle S1020i-PWH/PWR-GL Series**

The Gazelle DIN-Rail switches consist of compact and manageable industrial switches with a wide selection of port numbers, speed and media types. Gazelle S1010i-GL and Gazelle S1020i-GL series are designed for Automatic Control System (ACS) in industrial field, while Gazelle S1000i-Li and Gazelle S1020i-Li series are cost-efficient solutions designed to meet the requirements of safe city, smart transportation, and industrial data backhaul. In addition, the Gazelle S1020i-PWR-GL series and the Gazelle S1020i-PWH-GL Series provide port with standard IEEE802.3bt, IEEE802.3at, and IEEE802.1af support. All these DIN-Rail switches enable delivery of reliable, continuous, and manageable services by complying with some industrial regulations and standards, which can operate stably for a long time in harsh environments. Network redundancy and reliability are guaranteed with LACP, G.8032 ERPS (<50ms switch-over time). All these DIN-Rail switches are IP40 rated, support dual power supplies input, adopt low-power fanless cooling technology with a wide operating temperature ranging from - 40 to 75°C, and ensure up to 35-year Mean Time Between Failures (MTBF) and a 3-year warranty. They can support wall mounting and also rack mounting. Additionally, the Gazelle S1000i series, the Gazelle S1010i-GL Series, Gazelle S1020i-PWH-GL Series and the Gazelle S1020i(-PWR)-GL Series are designed to satisfy the requirements of data transmission in areas of smart grid (IEC 61850-3, IEEE 1613), transportation (EN50121-4), energy and industrial automation.



Gazelle S1000i-LI Series



Gazelle S1020i-GL Series



Gazelle S1020i-PWH-GL Series



Gazelle S1020i-LI Series

## Gazelle S1000i-LI Series Cost-effective L2 GE DIN-Rail

P/N	Gazelle S 1000i-2GF-8GE-LI	Gazelle S 1000i-2GF-4GE-LI	Gazelle S 1000i-4GF-8GE-LI
Port number & Type	2 x 100/1000M SFP + 8 x 10/100/1000M RJ45	2 x 100/1000M SFP + 4 x 10/100/1000M RJ45	4 x 100/1000M SFP + 8 x 10/100/1000M RJ45
Dimension(mm)	80(W) x 121(D) x 150(H)	56(W) x 105(D) x 135(H)	80(W) x 121(D) x 150(H)
Weight(kg)	1	1	1
Power Supply	AC: single input		
Voltage Scope	AC: 110V/220VAC (100~240VAC)		
MAX power(W)	7		11
Jumbo Frame	10K		
Switch Capacity	20	12	24
Working Temperature	-40°C to 75°C		
Protection Level	IP40		

## Gazelle S1010i-GL/S1020i-GL Series L2 GE DIN-Rail

P/N	Gazelle S1010i-GF-2GE-GL	Gazelle S1020i-2GF-4GE--GL	Gazelle S1020i-4GF-8GE-GL
Port number & Type	1 x 100M/1000M SFP + 2 x 10/100/1000M	2 x 100M/1000M SFP + 4 x 10/100/1000M	4 x 1000M SFP + 8 x 10/100/1000M
Dimension(mm)	56(W) x 105(D) x 135(H)		80(W) x 130(D) x 150(H)
Weight(kg)	0.7		1.0
Power Supply	AC: single input DCW24: dual input DCW48: dual input	AC: single input DCW48: dual input	
Voltage Scope	AC: 110V/220VAC (100~240VAC) 220VDC (170~300VDC) DCW24: 12V/24V(10~36VDC) DCW48: 24V/48V(20~72VDC)	AC: 110V/220VAC (100~240VAC) 220VDC (170~300VDC) DCW48: 24V/48V(20~72VDC)	
MAX power(W)	4	7	12
Jumbo Frame	10KB		
Switch Capacity	6	12	24
Working Temperature	-40°C to 75°C		
Protection Level	IP40		
Compliance	CE, UL/FCC IEC 61850-3, IEEE 1613, EN 50121-4		

## Gazelle S1020i-LI Series L2 GE DIN-Rail

P/N	Gazelle S1020i-2GF-4GE-LI	Gazelle S1020i-2GF-8GE-LI	Gazelle S1020i-4GF-8GE-LI
Port number & Type	2 x 1000M SFP + 4 x 10/100/1000M RJ45	2 x 1000M SFP + 8 x 10/100/1000M RJ45	4 x 1000M SFP + 8 x 10/100/1000M RJ45
Dimension(mm)	56(W) x 105(D) x 135(H)	80(W) x 130(D) x 150(H)	
Weight(kg)	0.7	1.0	1.1
Power Supply	DCW24: dual input		
Voltage Scope	DCW24: 12/24V(9~36VDC)		
MAX power(W)	7	8	12
Jumbo Frame	10KB		
Switch Capacity	12	20	24
Working Temperature	-40°C to 75°C		
Protection Level	IP40		

## Gazelle S1020i-PWH-GL/PWR-GL Series L2 GE PoE DIN-Rail

P/N	Gazelle S1020i-2GF-4GE-PWH-GL	Gazelle S1020i-4GF-8GE-PWH-GL	Gazelle S1020i-2GF-8GE-PWR-GL
Port number & Type	2 x 100/1000M SFP + 4 x 10/100/1000M RJ45 PoE	4 x 100/1000M SFP + 8 x 10/100/1000M RJ45 PoE	2 x 1000M SFP+ 8 x 10/100/1000M RJ45 PoE
Dimension(mm)	80(W) x 130(D) x 150(H)	98(W) x 155(D) x 177(H)	80(W) x 130(D) x 150(H)
Weight(kg)	0.9	1.5	0.9
Power Supply	DC48: dual input		
Voltage Scope	DCW48: 48V(44~57VDC)		
MAX power(W)	10+180	15+360	12+240
MAX POE power(W)	180	360	240
Jumbo Frame	9KB		10KB
Switch Capacity	12	24	20
Working Temperature	-40°C to 75°C		
Protection Level	IP40		
Compliance	CE, UL/FCC EN 50121-4		

## L2/L3 19" Rack-mounted Manageable Industrial Switch

**Gazelle S3028i-MGL, Gazelle S3028i-PWH-MGL**

**Gazelle S3028i-PWR-GS, ISCOM3052G(K)**

The Gazelle 19" rack-mounted switches are designed to satisfy the broadband backbone transportation and aggregation requirements under rigorous industrial and business conditions. The products support a flexible electrical and SFP optical interface with combinations of up to 4 x 10GE/GE uplinks and 48 x GE downlinks. Among these, ISCOM3052G(H) adopts a fully modular design, provides high-density interfaces, and is configurable and scalable. The Gazelle S3028i-PWH-MGL adopts a standard 1U chassis and offers high-density interfaces, including four 1/10 Gbit/s uplink optical interfaces, max twenty-four 100/1000 Mbit/s auto-negotiation downlink optical interfaces, and Max sixteen 1000 Mbit/s PoE interfaces. The Gazelle S3028i-MGL/ISCOM3052G(H) enable maximum flexibility when configured, in rings (intersect ring and tangent ring topologies), ensuring sub-50ms switchover time. Enhanced security is provided by supporting IEEE802.1x, RADIUS and other authentication methods. The Gazelle S3028i-MGL/ISCOM3052G(H) can sustain high performance in extreme environments. It also claims a fanless design, as well as IP40 dust protection housing, a redundant power supply, and is compliant with IEC 61850-3, IEEE 1613 and EN50121-4. All these switches adopt low-power fanless cooling technology with a wide operating temperature ranging from - 40 to 85°C, and ensure up to 35-year Mean Time Between Failures (MTBF) and a 3-year warranty.



Gazelle S3028i-MGL



ISCOM3052G(K)

P/N	Gazelle S3028i-4XF-16GE-PWH-MGL	Gazelle S3028i-4XF-16GE-MGL	Gazelle S3028i-4XF-16GF-MGL	ISCOM3052G(K)
Slot number & type	Uplink ports: 4 x 10GE SFP+ Downlink ports: 4x1G Combo+ 12 x 10/100/1000M RJ45(POE+/POE++) +1 x slot	Uplink ports: 4 x 10GE SFP+ Downlink ports: 4x1G Combo+ 12 x 10/100/1000M RJ45 +1 x slot	Uplink ports: 4 x 10GE SFP+ Downlink ports: 4x1G Combo+ 12 x 100/1000M SFP+1x slot	4 x 1G/10GE SFP+ uplink ports, 12 x GE RJ45 + 12 x GE Combo downlink ports. 3 x GE downlink slots Up to 48 GE port and 4 10GE
Card	Downlink Cards: 8GE: 8 x 10/100/1000M RJ45; 8GF: 8 x 100/1000M SFP			Downlink Cards: 8GE: 8 x 10/100/1000M RJ45 8GF: 8 x 100/1000M SFP
Dimension(mm)	1U, 19" 440(L) x 320(D) x 44(H)			2U, 440(W) x 360(D) x 88(H)
Weight(kg)	2.1			9.1
Power Supply	DC/D			AC/D, AC/S
MAX power(W)	50+480		50	N/A
MAX POE power(W)	480		N/A	N/A
Voltage Scope	HIP: 110/220VAC(100~240VAC) 110/220VDC(88~300 VDC) DC: 24/48VDC(20~72VDC)			AC: 110V/220VAC(100~240VAC) 220VDC(170~300VDC)
Jumbo Frame	10KB			12KB
Switch Capacity (Gbps)	128			176
Working Temperature	-40°C to 75°C			
Protection Level	IP40			
Compliance	CE, UL/FCC IEC 61850-3, IEEE 1613, EN 50121-4			

## 3G/4G Router

### Gazelle R102i, Gazelle R202i, Gazelle R202i-VM

The Gazelle R102i/R202i/R202i-VM Series provide solutions that satisfy the requirements for SME and outdoor networking deployment scenarios, such as financial industry, environmental protection, transportation, postal industry, monitoring, military, meteorology, utility and residential areas.

The Gazelle R102i/R202i/R202i-VM allows up to 6 Ethernet-based devices to simultaneously use a single cellular data account for primary or backup network connectivity to remote sites and devices. By integrating routers, switches, firewalls, VPN, and 3G/4G in a single device, the Gazelle Series provides the high performance, which is essential for concurrent services. These services include firewall, content filtering, encryption for VPNs, cellular data for mobility, data storage with USB 2.0, and quality-of-service (QoS) features for optimizing voice and video applications at broadband speeds. The use of this device significantly reduces both equipment and management costs.



Features/Device List	Gazelle R102i	Gazelle R202i-VM	Gazelle R202i
10/100/1000M Base-TX ports	N/A	1 port	6 ports (2 x SFP + 4 x RJ45)
10/100M Base-TX ports	4 ports	4 ports	N/A
3G Uplink	WCDMA		
4G Uplink	FDD/TD-LTE	FDD/TD-LTE (dual 4G modules)	FDD/TD-LTE (dual SIM cards)
Serial Interfaces	RS232/485/422 (DB9)	N/A	RS232+RS485 (PIN)
Power Supply	DC12V	DC12/24V	
Wi-Fi	N/A	802.11b/g/n	
Temp Range	-25°C to 70°C		
IP Level	IP40		
Installation	DIN-Rail	Wall-mount	DIN-Rail
Compliance	61850-3,1613, 50121-4		

## IoT Gateway

### Gazelle G312i, Gazelle G512i, Gazelle G532i

The Gazelle G series industrial IoT gateway transmits data from a large number of industrial devices in different areas to the remote cloud center for device monitoring, device diagnosis, program maintenance, and fault alarm, providing users with a simple and reliable remote transmission solution of industrial Internet data for industrial mutual control, device diagnosis, program maintenance and fault alarm.



## FEATURES

- High industrial protection level, ensuring long-term and stable operation of the device
- Offline cache of data, up to 1-month data
- Multiple network modes, supporting 2G/3G/4G networks of carriers and self-built Lora networks
- Multiple pre-configured cloud access capabilities, supporting PaaS networking
- Optional CAN expansion module, easily expanding various interfaces
- Container technology, facilitating secondary development for customers

Feature	Sub-feature	Gazelle G312i	Gazelle G512i	Gazelle G532i
Hardware performance	CPU	ARM Cortex-M7 400Mhz	ARM Cortex-A7 single-core 528Mhz-696Mhz	ARM Cortex-A53 dual-core 1.2Ghz
	Memory	N/A	512MB DDR3L	1GB DDR3L
	FLASH	N/A	1GB Nandflash	8GB eMMC
Interfaces	Serial interface	1 x RS485	1 x RS485	3 x RS485 1 x RS232
	Ethernet interface	2 x 100 Mbit/s RJ45	2 x 100 Mbit/s RJ45	WAN/LAN: 4 x 10/100/1000M RJ45 LAN: 4 x 10/100/1000M RJ45 + 2 x 100/1000M SFP
	Digital/Analog interface	12 x DI 6 x DO 2 x AI	N/A	N/A
	POE	N/A	N/A	802.3af/at/bt, up to 120W
	Wireless	Zigbee	Wi-Fi 802.11n 1x1	WiFi 802.11AC 2x2 support 2.4G/5G Zigbee
	4G/5G	N/A	LTE-FDD Band 1/3/5/7/8/20/28, LTE-TDD Band 38/40, UMTS Band 1/5/8	5G Band: N1/N2/N3/N5/N7/N8/N12/N20/N25/N28/ N40/N41/N66/N71/N77/N78/N79 • LTE-FDD Band: B1/B2/B3/B4/B5/B7/B8/B12/B13/B14/B17/ B18/B19/B20/B25/B26/B28/B29/B30/B32/ B66/B71 • LTE-TDD Band: B34/B38/B39/B40/B41/B42/B43/B48 • LTE DL 4x4 MIMO: B1/B2/B3/B4/B7/B25/B30/B38/B40/B41/ B42/B43/B48/B66 • UMTS Band: B1/B2/B3/B4/B5/B8
	SIM card	N/A	Mirco SIM card	Dual Mirco SIM card
	TF card	N/A	Up to 128 GB	N/A
Power Supply	Power interface	24 VDC	24 VDC	24 VDC
	Power Consumption	5W	7W	30W+POE 120W
Appearance	Dimension(mm)	56(W) × 105(D) × 135(H)	56(W) × 105(D) × 135(H)	80(W) × 130(W) × 150(H)
	Antenna	1 X RSMA	2 X SMA; 1 X RSMA	6 X SMA; 1 X RSMA
Working Environment	Protection Level	IP40	IP40	IP40
	Working Temperature	-40°C to 75°C	-40°C to 70°C	-25°C to 70°C
	Storage temperature	-40°C to 85°C	-40°C to 85°C	-40°C to 85°C
	Working humidity	5-95% RH (non-condensing)	5-95% RH (non-condensing)	5-95% RH (non-condensing)
Compliance	CE, UL/FCC			

## Chapter 8. Small Cell

Small cells are a critical piece in many network operators' plan. At the core, they provide network coverage to small areas. While tall and high powered macro cells keep the network signal strong across large distances, small cells are much more suitable for either densely populated areas like shopping malls, concert theatres, etc. or coverage enhancements in difficult terrains and/or rural areas.

Another goal of small cell technology is to improve the cellular experience for end users. It strengthens coverage and data transfer speeds where devices might otherwise compete for bandwidth. And small cells have been shown to extend handset battery life by reducing power draw, so devices can go longer between charges.



## Micro/Pico/Femto Cell Device

### BLBS3211-BxP43, BLBS3211-Bx, BLBS3221-Bx

To meet the requirements of mobile operators, Raisingcom has developed indoor and outdoor versions of 4G/LTE small cells. The Small Cell product family consists of outdoor micro cell BLBS3211-BxP43, enterprise level pico cell BLBS3211-Bx and home level femto cell BLBS3221-Bx. These small cells help operators to resolve the "coverage" issues as well as "capacity" issues. To improve poor signals reception indoors, our enterprise-level pico cell BLBS3211-Bx and home-level femto cells BLBS3221-Bx are able to improve the situation with quick and easy deployment. For larger areas like shopping malls with a lot of customer traffic, additional small cells can be deployed to further improve the capacity of the mall. For the rural area, Raisingcom also has a high power micro base station BLBS3211-BxP43 which can be deployed easily and provide easy ROI.



BLBS3221-Bx



BLBS3211-Bx



BLBS3211-BxP43

## FEATURES

- Integrate baseband, RF, and antenna into one, provide LTE throughput, and implement full functions of a LTE base station
- Feature intelligent SON, self-startup, automatic configuration, and flexible deployment
- Support multiple backhaul modes, such as xPON, IPRAN, and Internet

P/N	Outdoor micro cell BLBS3211-BxP43	Enterprise level pico cell BLBS3211-Bx	Home level femto cell BLBS3221-Bx
Working frequency band	Band 1, Band 3, Band 5, Band 8	Band 1, Band 3	Band 1, Band 3
System bandwidth	5M/10M/20 M	10M/20 M	10M/20 M
Maximum output power	2 x 20 W or 1 x 40 W	2 x 125 mW	2 x 50 mW
MIMO capacity	2 x 2 MIMO	2 x 2 MIMO	2 x 2 MIMO
User capacity	Support 128 activated users	Support 32 activated users and 96 online users per carrier	Support 16 activated users and 48 online users per carrier
Device weight	≤ 13 kg	≤ 0.8 kg	≤ 0.5 kg
Power supply mode	220 VAC power	PoE or 220 VAC power adaptor	Power adaptor
Device interface	1 WAN interface, 1 LAN interface, 1 SFP interface, 1 GPS interface	1 WAN interface, 1 LAN interface, 1 SFP interface, 1 GPS interface, and 1 USIM card socket	1 WAN interface, 1 LAN interface and 1 USIM card socket
Installation mode	Wall-mount or mask-mount	Ceiling-mount or wall-mount	Desktop
Working temperature	-40 to +55°C	-5 to +45°C	-5 to +40°C
Protection class	IP65	IP30 (indoor)	IP30 (indoor)

## Chapter 9. Multi-Service Access Platform

The Raisingcom last mile access platform offers flexibility and robustness for diverse data and voice applications at a low cost, with minimum deployment effort and optimized administration, management and operation. The Raisingcom packet transport networks (PTN) is a multi-core system that can carry any service over either SDH or IP/Ethernet infrastructures at the same time. They are perfect for enabling a smooth transition from TDM to IP. Besides, PCM for SCADA that designed especially for utility, industry, transportation and military application projects where special requirements must be fulfilled for mission-critical data and voice traffic. Raisingcom SCADA solution is known for its robustness and reliability in access networks. This has allowed us to continuously gain popularity in the following industries: power grid, water and natural gas, oil, mining and national security, public health and transportation. Raisingcom also includes mini-SDH, interface converter, multi-service fiber mux and multi-service modem pool in this product line.

## Multi-Service Chassis

### RC3000-15

The RC3000-15 is an intelligent multi-service access platform and is mainly applicable in dedicated networks, Utilities and Transportation transport networks. The device is a Digital Access and Cross-connect System (DACCS), which integrates the following functions: digital/analog access, cross-connection and transmission. The RC3000-15 is compatible with the Multi-Service Terminal Mux and can be synthe sized under the Raisecom NView system for real-time configuration, management, monitoring and trapping.

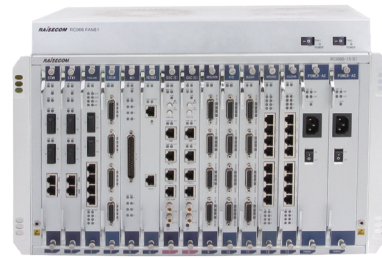

RC3000-15

## FEATURES

- Available with 4 x STM-1 and 2 x GE at line side; 7U chassis with 15 slots
- Non-blocking cross-connect of up to 4096 DS0 channels
- EOS
- 1+1 protection over STM-1 optical interface
- Available with sub-cards supporting E1, FE, FXS, FXO, 2/4W E&M, hotline co-directional 64K, V.24, RS232 at client side
- Software configurable attenuation of each audio interface
- Link Capacity Adjustment Scheme (LCAS) for inverse multiplex modules
- DXC module supports alarm input and output
- All sub-cards hot-swappable
- 1+1 protection on E1, PSU and DXC cards
- Power supply and fan modules with monitoring
- Auto Laser Shutdown (ALS) and Build-in BERT
- Inside and outside loopback for individual tributary cards
- VCC channel for remote network management
- SNMP (NView compatible) via in-band and out-of-band network channels

P/N	RC3000-15
Size/slot	7U/15-slot
Cross connect	512 Mbps
STM-1 interface	4
E1 channel	88
FXS/FXO channel	352
E&M channel	110
V.24 channel	88
RS232 channel	176
FE port	88

## System and Sub-cards

- RC3000-15-A, 7U/15-slot chassis with ventilation modules only
- RC3000-15-DXC, system management & Control Card
- RC3000-15-STM1, SDH aggregated unit with two STM-1 optical interfaces with SFP connector, 4 FE interfaces and 4 E1 unbalanced or balanced interfaces with DB37 connector
- RC3000-15-8E1, E1 tributary unit with 8E1 unbalanced or balanced interfaces, support one-plus-one port/card protection
- RC3000-15-32FXS, 2-wire Foreign Exchange Subscriber (FXS) interface card, 32 interfaces per card, DB37 connector
- RC3000-15-32FXO, 2-wire Foreign Exchange Office (FXO) interface card, 32 interfaces per card, DB37 connector
- RC3000-15-8S8O, 2-wire FXS and FXO interface card, 8-channel FXS and 8-channel FXO interfaces per card, DB37 connector
- RC3000-15-10E&M, 2/4 wire E&M interface card, 10 interfaces per card, RJ45 connector
- RC3000-15-16RS232, low speed RS232 data interface card, HDB26 connector
- RC3000-15-8V24H, low speed V.24 data interface card with handshaking, up to 128Kbps V.24 synchronous data 8 interfaces per card
- RC3000-15-16C64K, G.703 Co-directional of 64Kbps data interface card, 16 interfaces per card, RJ45 connector

## Dual-Core Architecture PTN Aggregation Platform

### iTN2100

The iTN2100 is a 6U/15-slot, high-capacity, modular PTN platform with a dual-core architecture for both Ethernet and TDM traffic delivery. It enables flexible and profitable deployment of carrier-grade business and mobile backhaul connections, and a smooth evolution from traditional to next-generation services. The iTN2100 supports up to 4 x 10G and/or 4 x STM-4/16 uplink capacities, and provides an efficient cross-connect, integration and transportation options over a wide range of copper/fiber based legacy and IP services. To maximize the uptime and to guarantee the carrier's network availability, iTN2100 supports full hardware redundancy, G.8032/G.8031 Ethernet and G.8131/Wrapping-Steering MPLS-TP protection. Extensive management capabilities are provided for all aspects from equipment installation and service provisioning to real-time system operation and performance monitoring. The iTN2100 offers cost-effective transport of MEF-compliant CE2.0 Ethernet services, E1/T1, fiber multiplexing, and pseudowire connectivity for lease-lined and 2G/3G/LTE mobile backhaul. In addition, the system also supports seamless connections with MPLS-TP and IP-MPLS backbones and converged fixed-mobile infrastructure by adopting SyncE and 1588v2 PTP. With this integrated system, carriers and ISPs can save on CAPEX and OPEX by implementing scalable networks that can easily grow with infrastructure and bandwidth demand in the future.

## FEATURES

- Combined dual cores can deliver Ethernet and TDM traffic in one system
- Available with 4 x 10G XFP and 4 x GE SFP, or 8 x GE SFP at line side and up to 128 x GE TSFP at client side
- Available with 4 x STM16 SFP or SFP at line side and up to 40 x STM1 SFP at client side
- Available with STM-1, EoTDM, PWE3, FiberMux, FE, DS3, E3, E1, Voice, V.35, V.24, RS232 at client side
- E-Line, E-LAN and E-Tree are compliant with CE2.0 relevant MEF specifications
- Uplink redundancy and resiliency with ITU-T G.8031 (ELPS), G.8032 (ERPS) on Ethernet side, G.8131 MPLS-TP liner protection and Wrapping/Steering MPLS-TP ring protection on PTN side and 1+1 liner MSP, SNCP, 1+1 LPP on SDH side
- IEEE802.3ah, 802.1ag, ITU-T Y.1731/SLA, L2MPLS-TP LSP/PW/section OAM
- VLAN, QinQ, QoS, LACP, and static MPLS compliant with MPLS-TP
- PWE3 tributary card supports SAToP, CESoP, MPLS, CESoETH (MEF) and UDP/IP encapsulations
- Port statistic based on VLAN/EVC/COS
- Compliant with 1588v2 (PTP) OC/BC/TC mode and SyncE
- Optional 2Mbit, 2MHz input/output external clock
- Full hardware redundant protections for GE, PWE3, SDH, Multi-service FiberMux sub-cards and power supply
- OAM for remote CPE management
- Auto Laser Shutdown (ALS) protection and Dying Gasp
- SNMP (NView compatible) via in-band and out-of-band network channels

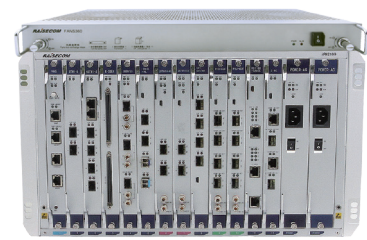

iTN2100

## System and Sub-cards

- iTN2100-12-A, 6U/15-slot chassis with ventilation modules only
- iTN2100-NMS, system management and control card
- iTN2100-NTU-2XG, 10G aggregation card with 2 x 10G XFP interfaces and 2 x GE SFP interfaces
- iTN2100-NTU-4GF, GE aggregation card with 4 x GE SFP interfaces and 1+1 card protection
- iTN2100-TSU, Clock card providing both IEEE1588 (PTP) and SYNC-E
- OPCOM3500E-4STM1-S, SDH aggregation card with 2 x STM1 or 2 x STM4 SFP interfaces
- iTN2100-2STM16-M, SDH aggregation card with 2 x STM-16 SFP interfaces, 2 CC3 external clock interfaces
- OPCOM3500E-4STM1, SDH tributary card with 4 x STM1 SFP interfaces
- iTN2100-8FX, GE tributary card with 8 x FE SFP interfaces
- iTN2100-8EOS-8GF, EoS tributary card with 8 x GE SFP interfaces enabling a Gigabit Ethernet service delivery over 8 x VCG
- iTN2100-CES-STM1/4, PWE3 tributary card with 4 x STM1 or 1 x STM4 SFP interfaces
- iTN2100-CES-16E1T1-BL, PWE3 tributary card with 8 RJ-45 ports, accessing 16 x E1 services
- OPCOM3500E-32/16E1, 32/16 E1 card
- OPCOM3500E-DXC-DS0 - DS0 based timeslot cross connection module
- OPCOM3500E-16C64K, G.703 tributary unit, 16 x ports
- OPCOM3500E-10E&M, 2/4wire E&M card with 10 interfaces
- OPCOM3500E-AUDIO-16M, 16 port FXS or FXO module
- OPCOM3500E-MULTI, Multi low speed service tributary card, provide 8 voice (FXS/FXO) interfaces, 4 audio interfaces with and 4 data (RS232/V.24 or RC485/422) interfaces

## Compact PTN Aggregation Platform

### iTN221

The iTN221 is a "Pizza Box" 1.5U (full ETSI) sized, next generation multiservice access node. It offers a dual core architecture for both packet and SDH/TDM transmission. The iTN221 supports up to 2 x 1G and/or 2 x STM-1/4 uplink capacities, and a built-in PDH multiplexer function, DXC non-blocking clock cross connect matrix at 64K level and TDM pseudo-wire functionality for TDM to Ethernet/IP/MPLS service migration. The iTN221 supports three service slots suitable for various sub cards: Voice (FXS/FXO/E&M), Ethernet (GE/FE), C37.94, 64K codirectional, Data RS232/RS485 etc. It provides utilities and transportation companies with reliable connectivity for controlling signals, mission critical data, voice, video monitoring and electrical protection services. It supports the smooth transition from PDH, SDH to the packet transmission network. For mission critical services, the system maximizes uptime and provides carrier-class network availability using G.8032/G.8031 Ethernet and G.8131/Wrapping-Steering MPLS-TP protection that provide sub-50msec recovery as well as hot swappable redundant power supplies. Extensive management capabilities are provided for all aspects from equipment installation and service provisioning to real-time system operation and performance monitoring. The iTN221 offers a cost-effective solutions for providing MEF-compliant CE2.0 Ethernet services, as well as E1 and pseudowire connectivity for lease-lined and 2G/3G/LTE mobile backhaul with integrated SyncE and 1588v2 PTP. Altogether, the iTN221 can be used to reduce CAPEX and OPEX and build a future-proof infrastructure that can scale both in capacity as well as migrate additional services to packet infrastructure without further equipment investment.



iTN221

## FEATURES

- Combined dual cores can deliver Ethernet and TDM traffic in one system
- Available with 2 x 1G SFP uplink, 4 x GE in the mainboard and 4 x GE sub-card module
- Available with 2 x STM-1/4 SFP
- Available with E1 TDM, E1 PWE3, GE, Voice, V.24/RS232, TP and 64K codirectional at client side
- E-Line, E-LAN and E-Tree are compliant with CE2.0 relevant MEF specifications
- Uplink redundancy and resiliency with ITU-T G.8031 (ELPS), G.8032 (ERPS) on Ethernet side, G.8131 MPLS-TP liner protection and wrapping/steering MPLS-TP ring protection on PTN side and 1+1 liner MSP, SNCP, 1+1 LPP on SDH side
- IEEE802.3ah, 802.1ag, ITU-T Y.1731/SLA, L2MPLS-TP LSP/PW/section OAM
- VLAN, QinQ, QoS, LACP, and static MPLS compliant with MPLS-TP
- PWE3 tributary card supports SAToP, CESoP, MPLS, CESoETH (MEF) and UDP/IP encapsulations
- Compliant with TC mode and SyncE
- 2Mbit, 2MHz input/output external clock
- Dry contact Alarm Relay (Input/output alarms)
- Extended temperature range (-20 to 65°C)
- Environmental Standards: CE, UL, EN 50121-4, IEC61000-4-2/3/4/5/6/7/8/9, 11/12/13/14, 29 IEC61850-3
- SNMP (NView compatible) via in-band and out-of-band network channels

## System and Sub-cards

- iTN221-4GE, including the chassis, main card, double power, fans, and three sub card slots
- The main card includes: 2 x STM-1/4, 2 x GE uplinks, 8 x E1 and 4 x GE user
- iTN221-SUB-16C64K, G.703 co-directional sub-card, 4 x ports
- iTN221-SUB-RS24, serial interface sub-card, provides 4 x V.24/RSV222/RS485 or 8 x RS232 ports
- iTN221-SUB-TP, C37.94 sub-card, support two pairs of optical interfaces for C37.94 service. Support standalone or protected bandwidth is N x 64k (N=1~12) every channel
- iTN221-SUB-10FXS/O, FXS/FXO sub-card, 10 x ports
- iTN221-SUB-4GE, provides 4 x GE service ports
- iTN221-SUB-4E1, E1 sub-card, 4 x ports
- iTN221-SUB-4E&M, E&M sub-card, 4 x ports
- iTN221-SUB-8MT, 8 magneto channel
- iTN221-SUB-V35, V.35/X.21 sub-card, 1 x port

P/N	iTN2100	iTN221
Chassis(high)	6U	1.5U
Number of Service slots	13	3
SDH cross-connect	86 x 86 VC4 or 4032 x 4032 VC12	8 x 8 VC4 or 504 x 504 VC12
Packet switch capacity	48G	16G
STM-16 interface	4	N/A
STM-1/4 interface	4	2
E1 channe	320	20
EOS interface	80	8
FE port	72	16
GE port	64 x GE for tributary, 8 x GE for aggregator	16
10GE port	4	N/A
PWE3	4 x STM4/16 x STM1	N/A
	128 x E1/T1	20 x E1/T1
PCM Interface	FXS/FXO/E&M/MT, V.24/RS232, G.703 CoDir	FXS/FXO/E&M/MT, V.24/RS232/RS422/RS485, G.703 CoDir, V.35, TP



# Chapter 10. Network Management System

The ultimate goal of developing a network management system is to maximize the network efficiency and minimize. This software is designed referring to FCAPS which TMN architecture and supports northbound interfaces for integration with Upper-Level NMS/OSS/BSS. The Raisecom NView NNM system is a Browser/Server system. Google Chrome and Firefox are supported.

This software can be deployed as EMS (Element Management System) to manage Raisecom network products with SNMP agent built in. The Raisecom NView NNM system contains topology, inventory, configuration, customer, fault, performance, security components and can manage sub-networks which structured by Raisecom network products and The Raisecom NView NNM system supports NBI for upper level NMS/OSS/BSS too. At the same time, we support SNMP MIBS to our partners for third parity EMS or NMS managing Raisecom products directly.

The Raisecom NView NNM system will support system HA, components' clustering and load balancing.

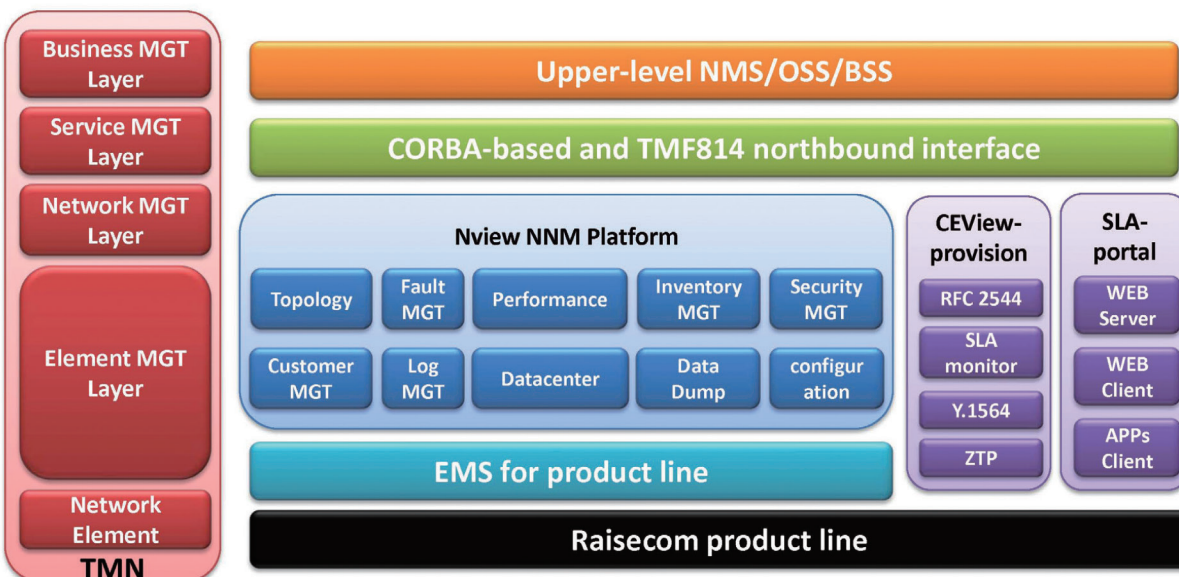
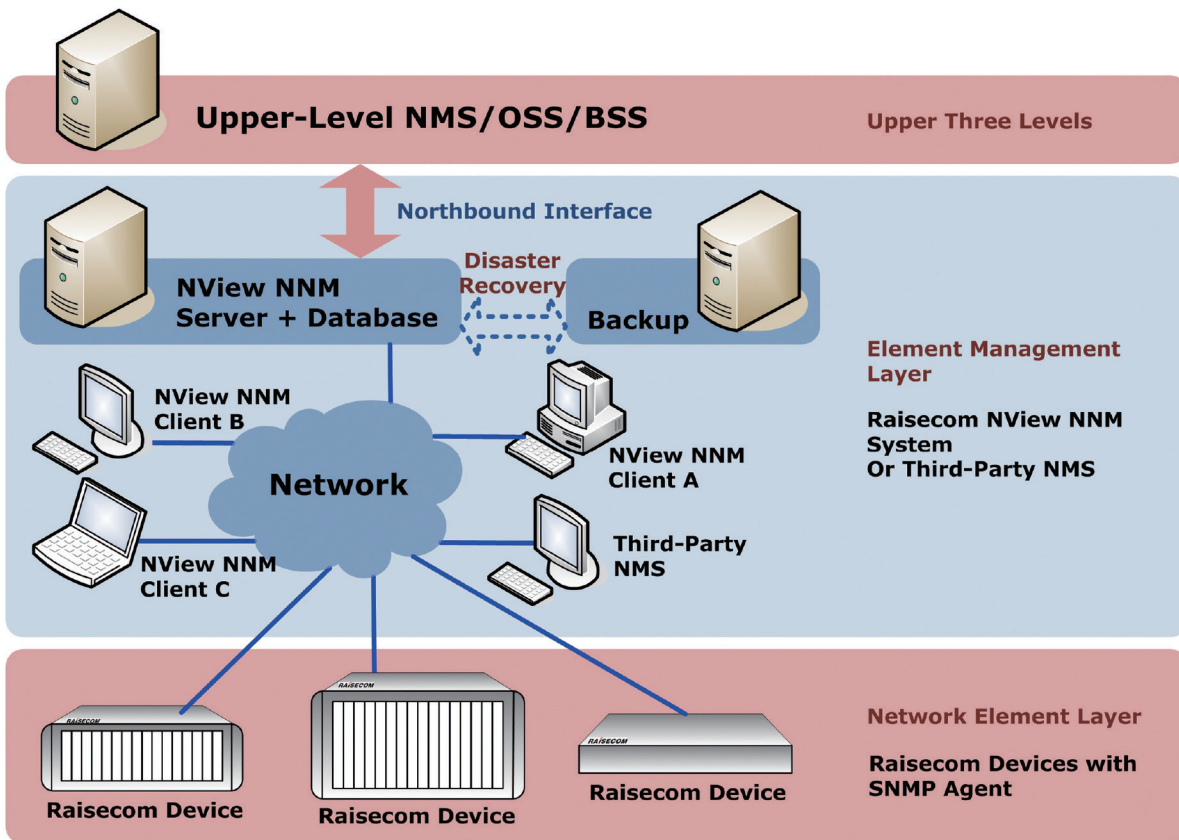

## Topology Management

The Raisecom NView NNM system displays all the graphic network elements and links. Dynamic network status indicators and alarms are displayed according to port, card, device, sub-network and network topology, facilitating network monitoring and directing the users clearly to the relevant information.

- Multi-level topology displaying
- Manual or automatic topology layout
- Devices auto-discovery
- Devices sub-graph auto-drawing
- Network topology pre-planning
- Clear indication of current alarm status and devices status
- Quick location of failure in the network
- Topology layout style customization

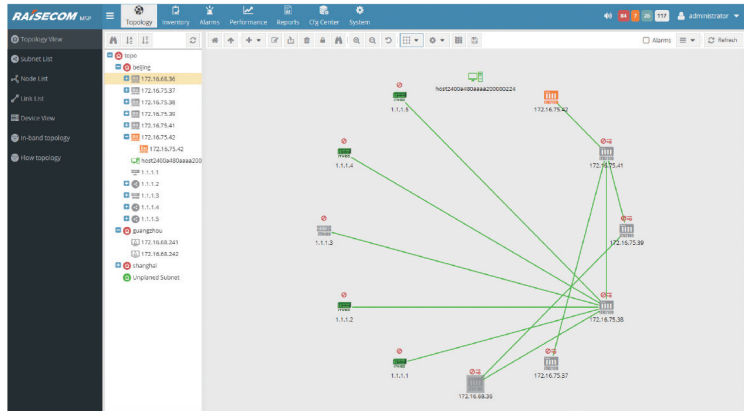

## Inventory Management

All resource-related information is displayed from different viewpoints in the inventory management module to assist network operators to manage resources uniformly and to provide a reliable basis for further network expansion.

- Unified management tool for resources, such as devices, chassis, slots, cards, and ports
- Comprehensive resource description, including customer and fault information
- Uniform query platform for rapid search of resources
- Synchronization mechanism that guarantees the system showing real-time status of network resources

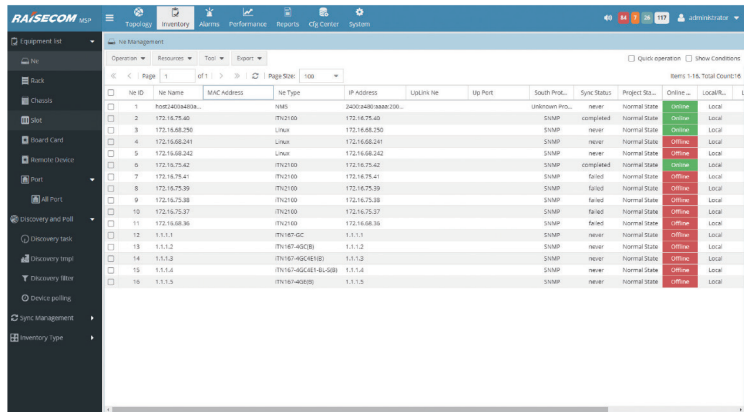

## Configuration Management

Easy management and provisioning is provided by a user-friendly point-and-click GUI with a realistic representation of devices.

- Uniform platform for different EMS systems, different devices share topology, resources, fault, performance, security functions
- User-friendly device status displayed on device panels drawn by EMS
- Real-time status feedback for every device configuration
- Centralized management of firmware and configure file, providing firmware and configure file upgrading to devices
- Massive configuration of devices
- Zero configuration mechanism

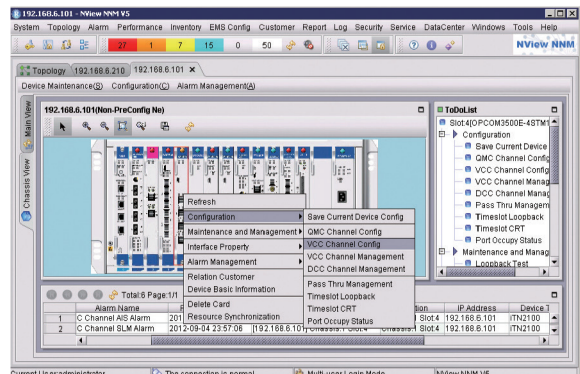
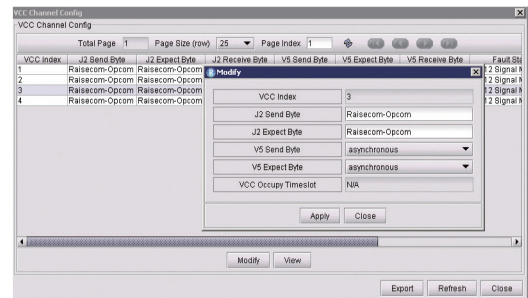

## Fault Management

The Raisecom NView NNM system supports advanced fault detection and analysis functions, real-time monitoring and alarm reporting. Full-scale alarm management information, such as alarm statistics, alarm location, alarm status, etc. helps the network operator recovering devices when necessary.

Alarm ID	Alarm Level	Alarm Name	Alarm Desc.	First Report Time	Last Report Time	Alarm Source	Alarm On Loc.	Alarm Source Type
761	Critical Alarm	Link Fault	2023-01-08 18:30:04	2023-01-11 14:18:29	172.16.75.139	shel1 1 slot4 ETL	Card	N
760	Critical Alarm	Link Fault	2023-01-08 18:38:13	2023-01-11 14:18:29	172.16.75.139	shel1 1 slot4 ETL	Card	N
23	Critical Alarm	Link Fault	2023-01-08 18:29:19	2023-01-11 14:18:29	172.16.75.139	shel1 1 slot4 ETL	Card	N
29	Critical Alarm	Link Fault	2023-01-08 18:30:06	2023-01-11 14:18:29	172.16.75.139	shel1 1 slot4 ETL	Card	N
803	Critical Alarm	Link Fault	2023-01-08 18:38:05	2023-01-11 14:18:29	172.16.75.139	shel1 1 slot4 ETL	Card	N
35	Critical Alarm	Link Fault	2023-01-08 18:28:04	2023-01-11 14:18:29	172.16.75.139	shel1 1 slot4 ETL	Card	N
48	Critical Alarm	Link Fault	2023-01-08 18:30:05	2023-01-11 14:18:29	172.16.75.139	shel1 1 slot4 ETL	Card	N
46	Critical Alarm	Link Fault	2023-01-08 18:38:05	2023-01-11 14:18:29	172.16.75.139	shel1 1 slot4 ETL	Card	N
53	Critical Alarm	Link Fault	2023-01-08 18:28:04	2023-01-11 14:18:29	172.16.75.139	shel1 1 slot4 ETL	Card	N
37	Critical Alarm	Link Fault	2023-01-08 18:38:13	2023-01-11 14:18:29	172.16.75.139	shel1 1 slot4 ETL	Card	N
68	Critical Alarm	Link Fault	2023-01-08 18:30:05	2023-01-11 14:18:29	172.16.75.139	shel1 1 slot4 ETL	Card	N
70	Critical Alarm	Link Fault	2023-01-08 18:38:05	2023-01-11 14:18:29	172.16.75.139	shel1 1 slot4 ETL	Card	N
74	Critical Alarm	Link Fault	2023-01-08 18:38:13	2023-01-11 14:18:29	172.16.75.139	shel1 1 slot4 ETL	Card	N
80	Critical Alarm	Link Fault	2023-01-08 18:28:04	2023-01-11 14:18:29	172.16.75.139	shel1 1 slot4 ETL	Card	N
7	Critical Alarm	Optical module R_LOS	2023-01-08 18:30:06	2023-01-11 14:18:29	172.16.75.139	shel1 1 slot4 ETL	Port	N
3	Critical Alarm	Optical module R_LOS	2023-01-08 18:38:05	2023-01-11 14:18:29	172.16.75.139	shel1 1 slot4 ETL	Port	N
4	Critical Alarm	Optical module R_LOS	2023-01-08 18:28:04	2023-01-11 14:18:29	172.16.75.139	shel1 1 slot4 ETL	Port	N
7	Critical Alarm	Optical module R_LOS	2023-01-08 18:30:06	2023-01-11 14:18:29	172.16.75.139	shel1 1 slot4 ETL	Port	N
8	Critical Alarm	Optical module R_LOS	2023-01-08 18:38:05	2023-01-11 14:18:29	172.16.75.139	shel1 1 slot4 ETL	Port	N
10	Critical Alarm	Optical module R_LOS	2023-01-08 18:28:04	2023-01-11 14:18:29	172.16.75.139	shel1 1 slot4 ETL	Port	N
14	Critical Alarm	Optical module R_LOS	2023-01-08 18:38:13	2023-01-11 14:18:29	172.16.75.139	shel1 1 slot4 ETL	Port	N
15	Critical Alarm	Optical module R_LOS	2023-01-08 18:30:06	2023-01-11 14:18:29	172.16.75.139	shel1 1 slot4 ETL	Port	N
13	Critical Alarm	Optical module R_LOS	2023-01-08 18:38:05	2023-01-11 14:18:29	172.16.75.139	shel1 1 slot4 ETL	Port	N
7	Critical Alarm	Optical module R_LOS	2023-01-08 18:30:06	2023-01-11 14:18:29	172.16.75.139	shel1 1 slot4 ETL	Port	N
18	Critical Alarm	Optical module R_LOS	2023-01-08 18:28:04	2023-01-11 14:18:29	172.16.75.139	shel1 1 slot4 ETL	Port	N
787	Critical Alarm	Optical module R_LOS	2023-01-08 18:38:05	2023-01-11 14:18:29	172.16.75.139	shel1 1 slot4 ETL	Port	N
79	Critical Alarm	Optical module R_LOS	2023-01-08 18:30:06	2023-01-11 14:18:29	172.16.75.139	shel1 1 slot4 ETL	Port	N
788	Critical Alarm	Optical module R_LOS	2023-01-08 18:38:13	2023-01-11 14:18:29	172.16.75.139	shel1 1 slot4 ETL	Port	N

- Standard five-level alarm display
- View and management of current and historical alarm management
- Grouped alarm monitoring according to customer requirements
- Ordered lists of alarms by importance with filter of rules
- Automatic alarm lists clearing
- Alarm forward service that forwards alarms received on NView NNM or EMS to third-party platforms via SNMP-trap
- Alarm troubleshooting library to recording troubleshooting experience

## Customer Management

The Customer Management module establishes the correlation between devices and customers to ensure efficient handling of information, particularly in the event of abnormal operation, when it is essential to troubleshoot and to quickly establish the problem that will bring about a more rapid solution.

Customer Name	Circuit ID	Customer Category	Customer Type	Contact Person	Contact Address	Contact
Jace	472873230021932	Key Customer	Bank	Level 2	80508	haidianshe@ND 23
Jilly	2388238230929034	General Customer	Hotel	Level 1	sidiffu	chus fluffhufflooth
Tom	110293847489303	General Customer	Community	Level 1	weizhoufuff	1283240
Alice	110293847489303	General Customer	Government	Level 3	weizhoufuff	15621
Jorge	sd2382884	Key Customer	Individual	Level 4	issasadio	socckloffs 111

- Centralized customer information management
- Customer-based resource management
- Customer-based fault management
- Import and export of customer information

## Performance Management

The NView NNM performance management function supports real-time monitoring of the SDH and Ethernet service performances to produce real-time as well as historical statistics for different periods. In addition, it also provides the basis for troubleshooting, fault speculation and network optimization.

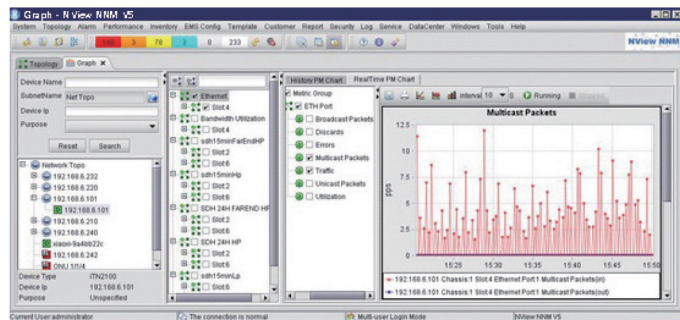

- Uniform performance management system for all devices under management
- Tailored deployment for network of different capacity
- Monitor device CPU and RAM utilization
- Collect PON/Ethernet/UNI/SDH port current and historical performance data
- Performance graph based on performance data collected
- Performance data export
- Actual performance metrics based on ITU-T Y.1731/SLA
- Metric template management



## Security Management

A number of user profiles and groups can be created in the security management module. However, only authorized users are allowed to login to the NView NNM system and operate it. This function protects all information on the system against illegal access, unauthorized use and other hazards.

- Multi-domain multi-authority management
- Different user profiles have different read and/or write authorities over devices in different subnets
- Client access control mechanism
- Unauthorized login deny mechanism
- Maintains system and device operation logs and supports log export

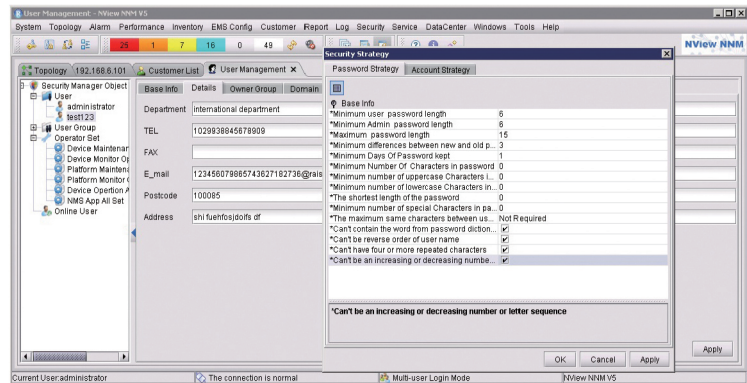

## Web Management

Web management can help network operators to manage devices based on GUI interface via a web browser if the device with web-server built in. It supports user management, configuration management, traffic statistics and devices status monitoring. Alarms can also be managed by NView NNM system. All these functions can minimize overall operational costs and reduce provisioning times.

- User-friendly, intuitive graphical configuration interface
- Operator authorization levels
- Unauthorized login deny mechanism
- Synchronization mechanism ensuring real-time status update of the devices

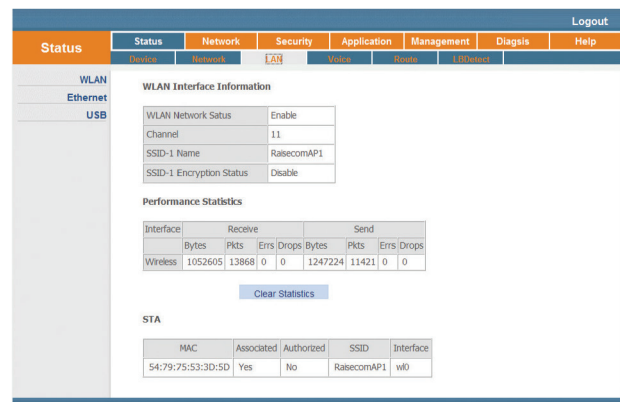

## Zero Touch Provisioning

In modern Carrier Ethernet networks, providers must consider a cross-functional automation that efficiently integrates commissioning, activation, inventory, fault, performance and network management. The challenging combination of the above capabilities is required for ensuring prompt new services launching, highly scalable network, effortless equipment roll-out and highest maintenance. In order to achieve such a level of automation, providers require an accurate and granular performance monitoring mechanism, combined with a fully-automated activation system. Zero touch provisioning allows service-providers to facilitate remote devices automatically without manual intervention. When remote devices are physically connected to the network and booted, the initial management IP can be automatically distributed to remote devices based on DHCP. When this occurs, the configuration and software updates can be automatically loaded into remote devices via a service template to perform a simple deployment minimizing human errors. This mechanism ensures lean TCO and therefore guarantees the modernization of packet networks.

- Simple procedure: Rack, connect and power on
- Diverse and editable service templates
- Topology auto-discovery mechanism
- Physical and logical graphic representation of links and nodes

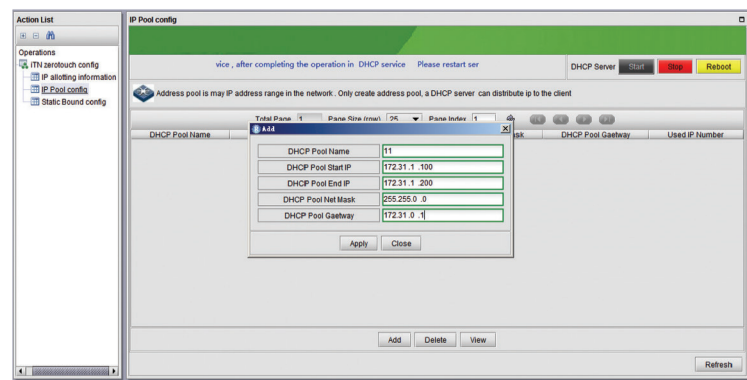

## SLA Portal

SLA portal provides various ways to real-time monitoring performance data that is collected from probes, includes of web client and APP client installed on the IOS or Android system.

In addition, an upper-level NMS/OSS/BSS can share data and results on the NView NNM system through the northbound interface. The system also provides a disaster recovery solution, protecting the server from critical disasters and ensuring continuous running of the system by setting up a backup server and keeping it constantly synchronized with the main one. In addition, SLA portal provides real-time monitoring to the devices performances collected from probes, and displays results from web client or IOS/Android smart phone APP client. Customer can export the performance report from smart phone.

The Raisecom SLA portal makes it simple for providers to optimize their network management. The easy management and monitoring result in a reduced workload. In addition, the simple operation and visual reports provide an improved service monitoring experience for customers.

- SLA KPI collection: Support collection of FD, IFDV, FLR, Bandwidth, Bandwidth Utilization
- Graphs: History and Real time display
- Export report: Support exporting history and Real time report
- Alarm: KPI exceed threshold, Device offline
- Logo: Customized Logo
- MAP: Support Google map
- WEB client: http, support IE10+/Firefox/Chrome/Safari browsers
- APPs: IOS, Android
- Capacity: 1000 total, 200 online, 20 concurrencies



#### **Raisecom Global Presence**

International Headquarters, **Raisecom Technology CO., LTD.**

East-11, Raisecom Building, No. 10 Xibeiwang East Road, Haidian District, Beijing, China, 100094

Tel: +86 10 8288 3305 Fax: +86 10 8288 3056

Email: [jiyanding@raisecom.com](mailto:jiyanding@raisecom.com) [www.raisecom.com](http://www.raisecom.com)

North American Headquarters, **Raisecom Inc.**

6380 N Eldridge Parkway Houston Texas 77401

Tel: +1 888 816 4808

Email: [sales@raisecominc.com](mailto:sales@raisecominc.com)

#### **Overseas Contacts**

Indonesia (Jakarta): [info-indonesia@raisecom.com](mailto:info-indonesia@raisecom.com)

Thailand (Bangkok): [info-thailand@raisecom.com](mailto:info-thailand@raisecom.com)

India (Mumbai): [info-india@raisecom.com](mailto:info-india@raisecom.com)

Germany (Frankfurt): [info-germany@raisecom.com](mailto:info-germany@raisecom.com)

France (Paris): [info-france@raisecom.com](mailto:info-france@raisecom.com)

Brazil (Sao Paulo): [info-brazil@raisecom.com](mailto:info-brazil@raisecom.com)

Africa (Morocco): [info-africa@raisecom.com](mailto:info-africa@raisecom.com)